



RU

Interval 60 min. 15 min.
 Binned(CL/SP) Count(volume)
Lane No 1 2

Direction Channel 1 MAINLINE WB 20F2
Direction Channel 2 R1 00579 WB 10F2
Unique ID# _____

Counter No. 172315 Count ID 15-001
SR 500 RRT/RRQ MP 5.83
Leg 2 Direction See 1,2 OSID _____

Station Description ON SR 500 E/O NE GHER RD/NE 112TH AVE I/C

Date	Day	Time	Comments				
4-20-15	2	1356	Manual (1) 1 (2) 1 Counter (1) 1 (2) 1	Set Cntrs	OK	TWB/DB	6.5
4-21-15	3	1227	Manual (1) 50 (2) 8 Counter (1) 50 (2) 8	Check Cntrs	OK	TWB/DB	6.8
4-22-15	4	0923	Manual (1) 50 (2) 7 Counter (1) 50 (2) 7	Check Cntrs	OK	TWB/DB	6.9
4-23-15	5	1035	Manual (1) 50 (2) 7 Counter (1) 50 (2) 7	Check Cntrs	OK	TWB/DB	7.2
4-24-15	6	0827	Manual (1) 1 (2) _____ Counter (1) 1 (2) _____	P/U Cntrs	OK	TWB/DB	6.5

Sketch

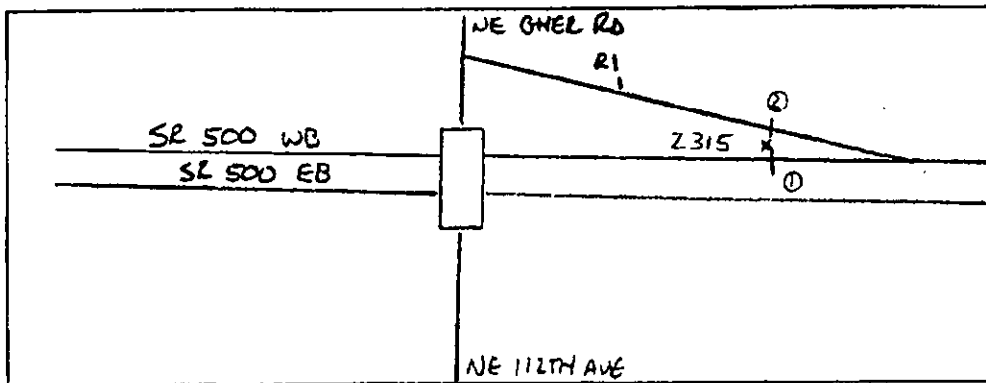

T. BREUKER
Field Person



Washington State
Department of Transportation

Ru

Diamond Traffic Counter

Interval 60 min. 15 min.
 Binned(CL/SP) Count(volume)
 Lane No 1 2

Direction Channel 1 MAINLINE EB 2 OF 2
 Direction Channel 2 Q1 00583 EB 1 OF 2
 Unique ID# _____

Counter No. 175863 Count ID 15-001
 SR 500 RRT/RRQ MP 5.83
 Leg 2 Direction See 1,2 OSID _____

Station Description ON SR 500 E/D NE GHER RD/NE 112TH AVE I/C

Date	Day	Time	Comments				
4-20-15	2	1311	Manual (1) 1 (2) 1 Counter (1) 1 (2) 1	Set Cntrs	OK	TWB/DB	6.4
4-21-15	3	1215	Manual (1) 50 (2) 15 Counter (1) 50 (2) 15	Check Cntrs	OK	TWB/DB	6.9
4-22-15	4	0917	Manual (1) 50 (2) 5 Counter (1) 50 (2) 5	Check Cntrs	OK	TWB/DB	6.9
4-23-15	5	1028	Manual (1) 50 (2) 5 Counter (1) 50 (2) 5	Check Cntrs	OK	TWB/DB	7.0
4-24-15	6	0820	Manual (1) 1 (2) _____ Counter (1) 1 (2) _____	P/U Cntrs	OK	TWB/DB	6.5

Sketch

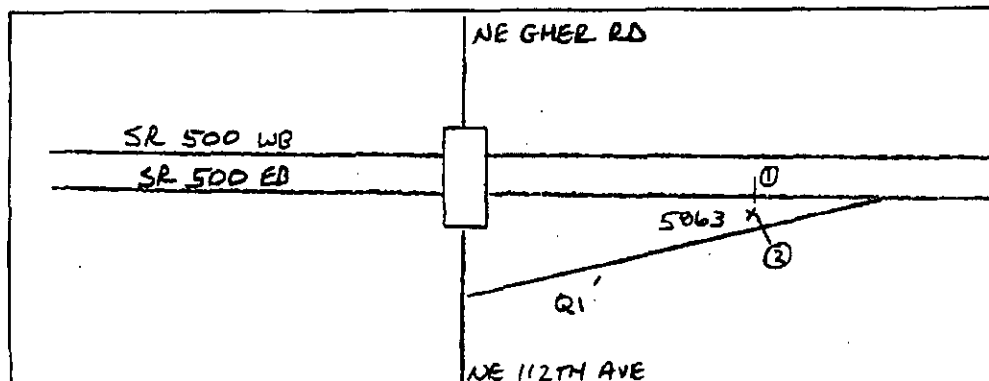

North

T BREUEL
Field Person

DOT-RN8515A-B

STATE OF WASHINGTON - DEPARTMENT OF TRANSPORTATION
TRIP SYSTEM
15 MINUTE TRAFFIC COUNT SUMMARY

DATE 04/29/15
TIME 10:31:21
PAGE 53

SR 500 MP 005.83 OFF SYSTEM ID. LEG 2 DIRECTION OF TRAFFIC WESTBOUND LANE 1 OF 2
COUNT IDENTIFIER 15-001 COUNTER NUMBER 172315 DESCRIPTION: ON SR 500 E/O NE GHER RD/NE 112TH AVE I/C

04/20/15 MONDAY	AM HOURS												PM HOURS												DAILY TOTAL	
	1	2	3	4	5	6	7	8	9	10	11	12	1	2	3	4	5	6	7	8	9	10	11	12		
12	1	2	3	4	5	6	7	8	9	10	11	12	1	2	3	4	5	6	7	8	9	10	11	12	1480	
00-15																										
15-30																										
30-45																										
45-00																										
TOT	12	1	2	3	4	5	6	7	8	9	10	11	12	1	2	3	4	5	6	7	8	9	10	11	12	1480

AM PEAK HOUR 0000 TO 0000 VOLUME 0
PM PEAK HOUR 0445 TO 0545 VOLUME 218

AM TOTAL 0
PM TOTAL 1480

04/21/15 TUESDAY	AM HOURS												PM HOURS												DAILY TOTAL
	1	2	3	4	5	6	7	8	9	10	11	12	1	2	3	4	5	6	7	8	9	10	11	12	
12	1	2	3	4 <td>5</td> <td>6</td> <td>7</td> <td>8</td> <td>9</td> <td>10</td> <td>11</td> <td>12</td> <td>1</td> <td>2</td> <td>3</td> <td>4</td> <td>5</td> <td>6</td> <td>7</td> <td>8</td> <td>9</td> <td>10</td> <td>11</td> <td>12</td> <td>3024</td>	5	6	7	8	9	10	11	12	1	2	3	4	5	6	7	8	9	10	11	12	3024
00-15																									
15-30																									
30-45																									
45-00																									
TOT	10	8	7	10	18	78	99	201	200	178	185	186	182	166	200	188	225	210	227	147	124	109	46	20	3024

AM PEAK HOUR 0715 TO 0815 VOLUME 215
PM PEAK HOUR 0430 TO 0530 VOLUME 229

AM TOTAL 1180
PM TOTAL 1844

04/22/15 WEDNESDAY	AM HOURS												PM HOURS												DAILY TOTAL
	1	2	3	4	5	6	7	8	9	10	11	12	1	2	3	4	5	6	7	8	9	10	11	12	
12	1	2	3	4 <td>5</td> <td>6</td> <td>7</td> <td>8</td> <td>9</td> <td>10</td> <td>11</td> <td>12</td> <td>1</td> <td>2</td> <td>3</td> <td>4</td> <td>5</td> <td>6</td> <td>7</td> <td>8</td> <td>9</td> <td>10</td> <td>11</td> <td>12</td> <td>3065</td>	5	6	7	8	9	10	11	12	1	2	3	4	5	6	7	8	9	10	11	12	3065
00-15																									
15-30																									
30-45																									
45-00																									
TOT	14	7	11	11	13	87	109	189	161	195	182	178	222	205	191	215	204	204	195	168	139	88	43	34	3065

AM PEAK HOUR 0845 TO 0945 VOLUME 201
PM PEAK HOUR 0330 TO 0430 VOLUME 233

AM TOTAL 1157
PM TOTAL 1908

STATE OF WASHINGTON - DEPARTMENT OF TRANSPORTATION
TRIP SYSTEM
15 MINUTE TRAFFIC COUNT SUMMARY

SR 500 MP 005.83 OFF SYSTEM ID. LEG 2 DIRECTION OF TRAFFIC WESTBOUND LANE 1 OF 2
COUNT IDENTIFIER 15-001 COUNTER NUMBER 172315 DESCRIPTION: ON SR 500 E/O NE GHER RD/NE 112TH AVE I/C

04/23/15	THURSDAY	AM HOURS												PM HOURS												DAILY TOTAL
		1	2	3	4	5	6	7	8	9	10	11	12	1	2	3	4	5	6	7	8	9	10	11	12	
12	1	2	3	4	5	6	7	8	9	10	11	12	1	2	3	4	5	6	7	8	9	10	11	12	1783	
00-15	4	3	4	2	1	9	20	41	33	42	40	35	43	40	42	38	51	61	48	42	32	30	17	6		
15-30	9	3	2	1	2	21	21	48	42	38	40	40	52	41	47	41	53	49	51	25	28	25	15	7		
30-45	3	2	1	3	4	16	31	51	58	32	40	45	48	42	42	55	69	48	36	41	19	20	5			
45-00	1	1	4	4	9	32	42	68	64	38	46	38	41	52	52	52	52	45	31	19	24	7	4			
TOT	17	9	7	14	16	78	114	208	197	150	161	158	184	175	183	174	211	231	192	134	120	98	59	22	2912	

AM PEAK HOUR 0700 TO 0800 VOLUME 208
PM PEAK HOUR 0500 TO 0600 VOLUME 231

AM TOTAL 1129
PM TOTAL 1783

04/24/15	FRIDAY	AM HOURS												PM HOURS												DAILY TOTAL
		1	2	3	4	5	6	7	8	9	10	11	12	1	2	3	4	5	6	7	8	9	10	11	12	
12	1	2	3	4	5	6	7	8	9	10	11	12	1	2	3	4	5	6	7	8	9	10	11	12	487	
00-15	3	3	3	5	9	17	27	50																		
15-30	3	4	1	2	1	25	22	50																		
30-45	3	2	4	3	14	21	63																			
45-00	9	1	4	3	25	39	60																			
TOT	18	10	12	13	12	73	99	200	50																487	

AM PEAK HOUR 0715 TO 0815 VOLUME 223
PM PEAK HOUR 0000 TO 0000 VOLUME 0

AM TOTAL 487
PM TOTAL 0

SR 500 MP 005.83 OFF SYSTEM ID. LEG 2 DIRECTION OF TRAFFIC WESTBOUND LANE 2 OF 2

COUNT IDENTIFIER 15-001 COUNTER NUMBER 172315 DESCRIPTION: ON SR 500 E/O NE GHER RD/NE 112TH AVE I/C

04/20/15 MONDAY	AM HOURS	PM HOURS	TOTAL
12	1	2	3
1	2	3	4
2	3	4	5
3	4	5	6
4	5	6	7
5	6	7	8
6	7	8	9
7	8	9	10
8	9	10	11
9	10	11	12
10	11	12	TOTAL
11	12		
12			
TOT			

AM PEAK HOUR 0000 TO 0000 VOLUME 0
 PM PEAK HOUR 0415 TO 0515 VOLUME 1549
 AM TOTAL 0
 PM TOTAL 9842

04/21/15 TUESDAY	AM HOURS	PM HOURS	TOTAL
12	1	2	3
1	2	3	4
2	3	4	5
3	4	5	6
4	5	6	7
5	6	7	8
6	7	8	9
7	8	9	10
8	9	10	11
9	10	11	12
10	11	12	TOTAL
11	12		
12			
TOT			

AM PEAK HOUR 0700 TO 0800 VOLUME 2147
 PM PEAK HOUR 0445 TO 0545 VOLUME 1575
 AM TOTAL 13067
 PM TOTAL 12762

04/22/15 WEDNESDAY	AM HOURS	PM HOURS	TOTAL
12	1	2	3
1	2	3	4
2	3	4	5
3	4	5	6
4	5	6	7
5	6	7	8
6	7	8	9
7	8	9	10
8	9	10	11
9	10	11	12
10	11	12	TOTAL
11	12		
12			
TOT			

AM PEAK HOUR 0700 TO 0800 VOLUME 2154
 PM PEAK HOUR 1245 TO 0145 VOLUME 1551
 AM TOTAL 12828
 PM TOTAL 13132

04/22/15 WEDNESDAY	AM HOURS	PM HOURS	TOTAL
12	1	2	3
1	2	3	4
2	3	4	5
3	4	5	6
4	5	6	7
5	6	7	8
6	7	8	9
7	8	9	10
8	9	10	11
9	10	11	12
10	11	12	TOTAL
11	12		
12			
TOT			

AM PEAK HOUR 0700 TO 0800 VOLUME 2154
 PM PEAK HOUR 1245 TO 0145 VOLUME 1551
 AM TOTAL 12828
 PM TOTAL 13132

STATE OF WASHINGTON - DEPARTMENT OF TRANSPORTATION

TRIP SYSTEM
15 MINUTE TRAFFIC COUNT SUMMARY

SR 500 MP 005.83 OFF SYSTEM ID. LEG 2 DIRECTION OF TRAFFIC WESTBOUND LANE 2 OF 2

COUNT IDENTIFIER	15-001	COUNTER NUMBER	DESCRIPTION: ON SR 500 E/O NE GHER RD/NE 112TH AVE I/C																									
			AM HOURS												PM HOURS													
			1	2	3	4	5	6	7	8	9	10	11	12	1	2	3	4	5	6	7	8	9	10	11	12	DAILY TOTAL	
04/23/15 THURSDAY			12	1	2	3	4	5	6	7	8	9	10	11	12	1	2	3	4	5	6	7	8	9	10	11	12	12888
TOT	112	98	100	208	499	1311	1930	2113	1891	1557	1517	1552	1460	1445	1440	1493	1438	1479	1232	844	684	536	401	196	25536			

AM PEAK HOUR 0700 TO 0800 VOLUME 2113
PM PEAK HOUR 0230 TO 0330 VOLUME 1510

AM TOTAL 12888
PM TOTAL 12648

04/24/15 FRIDAY		AM HOURS												PM HOURS												DAILY TOTAL
		1	2	3	4	5	6	7	8	9	10	11	12	1	2	3	4	5	6	7	8	9	10	11	12	
00-15	12	1	2	3	4	5	6	7	8	9	10	11	12	1	2	3	4	5	6	7	8	9	10	11	12	6237
15-30	1	2	3	4	5	6	7	8	9	10	11	12	1	2	3	4	5	6	7	8	9	10	11	12	0	
30-45	1	2	3	4	5	6	7	8	9	10	11	12	1	2	3	4	5	6	7	8	9	10	11	12	0	
45-00	1	2	3	4	5	6	7	8	9	10	11	12	1	2	3	4	5	6	7	8	9	10	11	12	0	
TOT	100	90	124	191	446	1130	1800	1936	420	420	1936	0	6237	0	6237	0										

AM PEAK HOUR 0700 TO 0800 VOLUME 1936
PM PEAK HOUR 0000 TO 0000 VOLUME 0

AM TOTAL 6237
PM TOTAL 0

SR 500 MP 005.83 OFF SYSTEM ID. LEG 2 DIRECTION OF TRAFFIC WESTBOUND LANE 12 OF 2

COUNT IDENTIFIER 15-001 COUNTER NUMBER 172315 DESCRIPTION: ON SR 500 E/O NE GHER RD/NE 112TH AVE I/C

COUNT IDENTIFIER	DATE	DAY	AM HOURS												PM TOTAL	DAILY TOTAL										
			1	2	3	4	5	6	7	8	9	10	11	12												
04/20/15	MONDAY		1	2	3	4	5	6	7	8	9	10	11	12	1671	1698	1614	1718	1376	1000	852	678	456	259	11322	
TOT																										

AM PEAK HOUR 0000 TO 0000 VOLUME 0
PM PEAK HOUR 0415 TO 0515 VOLUME 1763

AM TOTAL 0
PM TOTAL 11322

COUNT IDENTIFIER	DATE	DAY	AM HOURS												PM TOTAL	DAILY TOTAL																							
			1	2	3	4	5	6	7	8	9	10	11	12																									
04/21/15	TUESDAY		1	2	3	4	5	6	7	8	9	10	11	12	137	126	144	230	552	1428	2069	2348	2124	1809	1678	1602	1583	1577	1648	1681	1764	1720	1503	1066	780	639	417	228	28853
TOT																																							

AM PEAK HOUR 0700 TO 0800 VOLUME 2348
PM PEAK HOUR 0430 TO 0530 VOLUME 1803

AM TOTAL 14247
PM TOTAL 14606

COUNT IDENTIFIER	DATE	DAY	AM HOURS												PM TOTAL	DAILY TOTAL																							
			1	2	3	4	5	6	7	8	9	10	11	12																									
04/22/15	WEDNESDAY		1	2	3	4	5	6	7	8	9	10	11	12	152	98	121	207	512	1437	2030	2343	1963	1844	1699	1579	1759	1739	1690	1719	1697	1665	1440	1100	911	649	421	250	29025
TOT																																							

AM PEAK HOUR 0700 TO 0800 VOLUME 2343
PM PEAK HOUR 1245 TO 0145 VOLUME 1761

AM TOTAL 13985
PM TOTAL 15040

DOT-RN8515A-B

STATE OF WASHINGTON - DEPARTMENT OF TRANSPORTATION
TRIP SYSTEM
15 MINUTE TRAFFIC COUNT SUMMARY

DATE 04/29/15
TIME 10:31:21
PAGE 58

SR 500 MP 005.83 OFF SYSTEM ID. LEG 2 DIRECTION OF TRAFFIC WESTBOUND LANE 12 OF 2

COUNT IDENTIFIER 15-001 COUNTER NUMBER 172315 DESCRIPTION: ON SR 500 E/O NE GHER RD/NE 112TH AVE I/C

04/23/15	THURSDAY												AM TOTAL	PM TOTAL	DAILY TOTAL										
	AM HOURS						PM HOURS																		
	1	2	3	4	5	6	7	8	9	10	11	12	1	2	3	4	5	6	7	8	9	10	11	12	
00-15	12	1	2	3	4	5	6	7	8	9	10	11	12	1	2	3	4	5	6	7	8	9	10	11	12
15-30	42	30	30	34	70	233	492	568	507	392	435	401	375	352	387	401	383	434	349	290	230	192	153	55	
30-45	35	23	25	55	108	302	504	554	555	433	383	428	431	427	383	429	460	419	374	245	219	193	118	56	
45-00	29	30	33	70	168	420	547	608	533	441	413	454	398	429	434	636	411	436	352	251	181	130	112	65	
TOT	129	107	107	222	515	1389	2044	2321	2088	1707	1678	1710	1644	1620	1623	1667	1649	1710	1424	978	804	634	460	218	

AM PEAK HOUR 0700 TO 0800 VOLUME 2321
PM PEAK HOUR 0500 TO 0600 VOLUME 1710

04/24/15	FRIDAY												AM TOTAL	PM TOTAL	DAILY TOTAL										
	AM HOURS						PM HOURS																		
	1	2	3	4	5	6	7	8	9	10	11	12	1	2	3	4	5	6	7	8	9	10	11	12	
00-15	12	1	2	3	4	5	6	7	8	9	10	11	12	1	2	3	4	5	6	7	8	9	10	11	12
15-30	42	26	31	29	72	187	441	477	470	470	470	470	470	470	470	470	470	470	470	470	470	470	470	470	470
30-45	37	30	38	51	86	283	483	538	538	538	538	538	538	538	538	538	538	538	538	538	538	538	538	538	538
45-00	32	20	38	64	148	364	506	564	564	564	564	564	564	564	564	564	564	564	564	564	564	564	564	564	564
TOT	118	100	136	204	458	1203	1899	2136	470	470	470	470	470	470	470	470	470	470	470	470	470	470	470	470	470

AM PEAK HOUR 0700 TO 0800 VOLUME 2136
PM PEAK HOUR 0000 TO 0000 VOLUME 0

04/20/15 THRU 04/24/15 90
TOTAL HOURS FOR COUNT
3 DAYS
AVG WEEKDAY VOL 28775 X SEASONAL ADJ. FACTOR 0.9400 = 27049 X AXLE CORR FACTOR 0.9810 = ESTIMATED AVG DAILY TRAFFIC 26535

FACTOR GROUP GR-02
FACTOR GROUP GR-B2

DOT-RN8515A-8

STATE OF WASHINGTON - DEPARTMENT OF TRANSPORTATION

TRIP SYSTEM
15 MINUTE TRAFFIC COUNT SUMMARY

DATE 04/29/15
TIME 10:31:21
PAGE 59

SR 500 MP 005.83 OFF SYSTEM ID. LEG 2 DIRECTION OF TRAFFIC EASTBOUND LANE 1 OF 2

COUNT IDENTIFIER	15-001	COUNTER NUMBER	175863	DESCRIPTION:	ON SR 500 E/O NE GHER RD/NE 112TH AVE 1/C
04/20/15 MONDAY					
	12	1	2	3	4
	1	2	3	4	5
	2	3	4	5	6
	3	4	5	6	7
	4	5	6	7	8
	5	6	7	8	9
	6	7	8	9	10
	7	8	9	10	11
	8	9	10	11	12
	9	10	11	12	TOTAL
00-15					50
15-30					56
30-45					57
45-00					63
TOT					175
					217
					246
					249
					227
					222
					162
					135
					83
					66
					35
					1817

AM PEAK HOUR 0000 TO 0000 VOLUME 0
PM PEAK HOUR 0345 TO 0445 VOLUME 261

AM TOTAL 0
PM TOTAL 1817

COUNT IDENTIFIER	15-001	COUNTER NUMBER	175863	DESCRIPTION:	ON SR 500 E/O NE GHER RD/NE 112TH AVE 1/C
04/21/15 TUESDAY					
	12	1	2	3	4
	1	2	3	4	5
	2	3	4	5	6
	3	4	5	6	7
	4	5	6	7	8
	5	6	7	8	9
	6	7	8	9	10
	7	8	9	10	11
	8	9	10	11	12
	9	10	11	12	TOTAL
00-15					18
15-30					33
30-45					42
45-00					53
TOT					124
					173
					184
					193
					196
					180
					216
					240
					246
					267
					239
					231
					172
					176
					106
					58
					31
					3270

AM PEAK HOUR 0945 TO 1045 VOLUME 198
PM PEAK HOUR 0400 TO 0500 VOLUME 267

AM TOTAL 1108
PM TOTAL 2162

COUNT IDENTIFIER	15-001	COUNTER NUMBER	175863	DESCRIPTION:	ON SR 500 E/O NE GHER RD/NE 112TH AVE 1/C
04/22/15 WEDNESDAY					
	12	1	2	3	4
	1	2	3	4	5
	2	3	4	5	6
	3	4	5	6	7
	4	5	6	7	8
	5	6	7	8	9
	6	7	8	9	10
	7	8	9	10	11
	8	9	10	11	12
	9	10	11	12	TOTAL
00-15					17
15-30					30
30-45					47
45-00					57
TOT					111
					161
					171
					195
					209
					236
					262
					217
					288
					225
					234
					235
					153
					166
					82
					51
					39
					3304

AM PEAK HOUR 1030 TO 1130 VOLUME 213
PM PEAK HOUR 0300 TO 0400 VOLUME 288

AM TOTAL 1116
PM TOTAL 2188

SR 500 MP 005.83 OFF SYSTEM ID. LEG 2 DIRECTION OF TRAFFIC EASTBOUND LANE 1 OF 2

COUNT IDENTIFIER 15-001 COUNTER NUMBER 175863 DESCRIPTION: ON SR 500 E/O NE GHER RD/NE 112TH AVE I/C

04/23/15	THURSDAY												AM HOURS	PM HOURS	DAILY TOTAL										
	1	2	3	4	5	6	7	8	9	10	11	12													
00-15	7	2	1	3	7	18	30	41	46	43	59	53	52	60	62	63	46	43	23	34	24	9			
15-30	3	6	7	4	5	17	46	40	33	36	37	61	50	57	73	68	46	57	44	18	13	4			
30-45	7	8	3	3	10	20	54	32	46	57	55	47	62	61	75	57	53	36	28	26	12	12			
45-00	3	4	5	5	6	17	49	50	39	47	47	52	58	63	74	53	71	41	26	16	10	6			
TOT	20	20	16	15	14	39	96	179	163	164	183	175	219	223	233	255	284	241	216	177	121	94	59	31	3237
													AM PEAK HOUR 0715 TO 0815 VOLUME	190	AM TOTAL	1084									
													PM PEAK HOUR 0415 TO 0515 VOLUME	285	PM TOTAL	2153									

04/24/15	FRIDAY												AM HOURS	PM HOURS	DAILY TOTAL										
	1	2	3	4	5	6	7	8	9	10	11	12													
00-15	9	4	2	2	2	3	19	31	41	46	59	53	52	60	62	63	46	43	23	34	24	9			
15-30	5	2	2	2	1	10	20	46	40	33	36	37	61	50	57	73	68	46	57	44	18	13	4		
30-45	8	6	3	3	4	15	20	50	32	46	57	55	47	62	61	75	57	53	36	28	26	12	12		
45-00	6	3	2	2	5	17	36	48	50	39	47	47	52	58	63	74	53	71	41	26	16	10	6		
TOT	28	15	8	10	12	45	95	175	163	164	183	175	219	223	233	255	284	241	216	177	121	94	59	31	428
													AM PEAK HOUR 0715 TO 0815 VOLUME	184	AM TOTAL	428									
													PM PEAK HOUR 0000 TO 0000 VOLUME	0	PM TOTAL	0									

SR 500 MP 005.83 OFF SYSTEM ID. LEG 2 DIRECTION OF TRAFFIC EASTBOUND LANE 2 OF 2

COUNT IDENTIFIER 15-001 COUNTER NUMBER 175863 DESCRIPTION: ON SR 500 E/O NE GHER RD/NE 112TH AVE I/C

04/20/15 MONDAY	AM HOURS	PM HOURS	AM TOTAL	PM TOTAL	DAILY TOTAL																				
12	1	2	3	4	5	6	7	8	9	10	11	12	TOTAL												
1	2	3	4	5	6	7	8	9	10	11	12	TOTAL	15240												
00-15	65	49	39	21	21	50	130	247	241	292	281	321	376	413	405	489	556	542	456	355	318	268	167	134	
15-30	82	35	35	30	28	73	160	316	319	263	285	307	391	438	439	525	542	564	499	380	273	257	164	120	
30-45	57	41	39	22	34	82	203	317	323	269	319	332	392	371	458	543	563	527	427	326	291	273	169	107	
45-00	58	36	29	28	39	149	276	314	291	290	283	336	377	400	539	527	565	508	380	311	289	195	130	63	
TOT	262	161	142	101	122	354	769	1194	1174	1114	1168	1296	1536	1622	1841	2084	2226	2141	1762	1372	1171	993	630	424	25659

AM PEAK HOUR 0000 TO 0000 VOLUME 0
 PM PEAK HOUR 0430 TO 0530 VOLUME 2179
 AM TOTAL 0
 PM TOTAL 15240

04/21/15 TUESDAY	AM HOURS	PM HOURS	AM TOTAL	PM TOTAL	DAILY TOTAL																				
12	1	2	3	4	5	6	7	8	9	10	11	12	TOTAL												
1	2	3	4	5	6	7	8	9	10	11	12	TOTAL	17558												
00-15	79	63	45	31	27	60	127	237	259	286	276	317	338	392	393	503	541	579	526	374	275	296	176	108	
15-30	63	46	39	36	34	70	179	329	284	260	284	300	374	367	446	528	570	563	452	317	304	257	149	127	
30-45	51	37	41	28	36	98	217	317	276	267	317	327	335	429	419	586	554	513	411	316	279	230	135	111	
45-00	47	31	46	43	52	119	302	362	336	278	291	336	403	378	487	561	564	489	415	307	267	186	124	84	
TOT	240	177	171	138	149	347	825	1245	1155	1091	1168	1280	1450	1566	1765	2178	2229	2144	1804	1314	1125	969	584	430	25544

AM PEAK HOUR 1100 TO 1200 VOLUME 1280
 PM PEAK HOUR 0415 TO 0515 VOLUME 2267
 AM TOTAL 7986
 PM TOTAL 17558

04/22/15 WEDNESDAY	AM HOURS	PM HOURS	AM TOTAL	PM TOTAL	DAILY TOTAL																				
12	1	2	3	4	5	6	7	8	9	10	11	12	TOTAL												
1	2	3	4	5	6	7	8	9	10	11	12	TOTAL	17802												
00-15	65	49	39	21	21	50	130	247	241	292	281	321	376	413	405	489	556	542	456	355	318	268	167	134	
15-30	82	35	35	30	28	73	160	316	319	263	285	307	391	438	439	525	542	564	499	380	273	257	164	120	
30-45	57	41	39	22	34	82	203	317	323	269	319	332	392	371	458	543	563	527	427	326	291	273	169	107	
45-00	58	36	29	28	39	149	276	314	291	290	283	336	377	400	539	527	565	508	380	311	289	195	130	63	
TOT	262	161	142	101	122	354	769	1194	1174	1114	1168	1296	1536	1622	1841	2084	2226	2141	1762	1372	1171	993	630	424	25659

AM PEAK HOUR 1100 TO 1200 VOLUME 1296
 PM PEAK HOUR 0430 TO 0530 VOLUME 2234
 AM TOTAL 7857
 PM TOTAL 17802

DOT-RNB515A-8

STATE OF WASHINGTON - DEPARTMENT OF TRANSPORTATION
TRIP SYSTEM
15 MINUTE TRAFFIC COUNT SUMMARY

DATE 04/29/15
TIME 10:31:21
PAGE 62

SR 500 MP 005.83 OFF SYSTEM ID. LEG 2 DIRECTION OF TRAFFIC EASTBOUND LANE 2 OF 2

COUNT IDENTIFIER	15-001	COUNTER NUMBER	175863	DESCRIPTION:	ON SR 500 E/O NE GHER RD/NE 112TH AVE I/C																				
04/23/15 THURSDAY																									
	12	1	2	3	4																				
	1	2	3	4	5																				
	2	3	4	5	6																				
	3	4	5	6	7																				
	4	5	6	7	8																				
	5	6	7	8	9																				
	6	7	8	9	10																				
	7	8	9	10	11																				
	8	9	10	11	12																				
	9	10	11	12	DAILY TOTAL																				
00-15	76	56	35	29	26	54	138	277	269	314	282	351	388	404	436	553	464	553	450	327	268	287	201	134	
15-30	84	35	32	21	25	73	173	297	285	280	298	339	330	391	440	576	510	550	522	356	293	241	166	115	
30-45	51	36	33	36	27	94	232	304	303	219	316	359	376	397	457	561	558	555	400	339	288	221	125	82	
45-00	55	33	36	30	50	133	273	351	276	300	312	359	354	418	441	506	541	536	395	296	284	193	154	86	
HOUR																									
TOT	266	160	136	116	128	354	816	1229	1133	1113	1208	1408	1448	1610	1774	2196	2073	2194	1767	1318	1133	942	646	417	25585

AM PEAK HOUR 1100 TO 1200 VOLUME 1408
PM PEAK HOUR 0430 TO 0530 VOLUME 2202

AM TOTAL 8067
PM TOTAL 17518

04/24/15 FRIDAY	12	1	2	3	4	5	6	7	8	9	10	11	12	1	2	3	4	5	6	7	8	9	10	11	12	DAILY TOTAL
	12	1	2	3	4	5	6	7	8	9	10	11	12	1	2	3	4	5	6	7	8	9	10	11	12	DAILY TOTAL
00-15	73	49	38	21	27	53	116	274	287																	
15-30	84	47	31	20	23	79	137	280																		
30-45	67	36	32	30	30	80	218	325																		
45-00	79	37	41	33	37	131	296	309																		
TOT	303	169	162	106	117	343	767	1188	287																	3442

AM PEAK HOUR 0715 TO 0815 VOLUME 1201
PM PEAK HOUR 0000 TO 0000 VOLUME 0

AM TOTAL 3442
PM TOTAL 0

SR 500 MP 005.83 OFF SYSTEM ID. LEG 2 DIRECTION OF TRAFFIC EASTBOUND LANE 12 OF 2

COUNT IDENTIFIER 15-001 COUNTER NUMBER 175863 DESCRIPTION: ON SR 500 E/O NE GHER RD/NE 112TH AVE I/C

04/20/15 MONDAY	AM HOURS	PM HOURS	DAILY TOTAL
12	1	2	3
1	2	3	4
2	3	4	5
3	4	5	6
4	5	6	7
5	6	7	8
6	7	8	9
7	8	9	10
8	9	10	11
9	10	11	12
10	11	12	TOTAL
11	12		
12			
TOT			17057

AM PEAK HOUR 0000 TO 0000 VOLUME 0
PM PEAK HOUR 0430 TO 0530 VOLUME 2427

AM TOTAL 0
PM TOTAL 17057

04/21/15 TUESDAY	AM HOURS	PM HOURS	DAILY TOTAL
12	1	2	3
1	2	3	4
2	3	4	5
3	4	5	6
4	5	6	7
5	6	7	8
6	7	8	9
7	8	9	10
8	9	10	11
9	10	11	12
10	11	12	TOTAL
11	12		
12			
TOT			28814

AM PEAK HOUR 1100 TO 1200 VOLUME 1476
PM PEAK HOUR 0415 TO 0515 VOLUME 2516

AM TOTAL 9094
PM TOTAL 19720

04/22/15 WEDNESDAY	AM HOURS	PM HOURS	DAILY TOTAL
12	1	2	3
1	2	3	4
2	3	4	5
3	4	5	6
4	5	6	7
5	6	7	8
6	7	8	9
7	8	9	10
8	9	10	11
9	10	11	12
10	11	12	TOTAL
11	12		
12			
TOT			28963

AM PEAK HOUR 1100 TO 1200 VOLUME 1505
PM PEAK HOUR 0430 TO 0530 VOLUME 2458

AM TOTAL 8973
PM TOTAL 19990

DOT-RNB515A-B

STATE OF WASHINGTON - DEPARTMENT OF TRANSPORTATION
TRIP SYSTEM
15 MINUTE TRAFFIC COUNT SUMMARY

DATE 04/29/15
TIME 10:31:21
PAGE 64

SR 500 MP 005.83 OFF SYSTEM ID. LEG 2 DIRECTION OF TRAFFIC EASTBOUND LANE 12 OF 2

COUNT IDENTIFIER 15-001 COUNTER NUMBER 175863 DESCRIPTION: ON SR 500 E/O NE GHER RD/NE 112TH AVE I/C

04/23/15 THURSDAY	AM HOURS												PM HOURS												DAILY TOTAL
	1	2	3	4	5	6	7	8	9	10	11	12	1	2	3	4	5	6	7	8	9	10	11	12	
12	1	2	3	4	5	6	7	8	9	10	11	12	1	2	3	4	5	6	7	8	9	10	11	12	143
83	58	36	32	27	61	156	307	310	360	325	387	447	457	488	613	526	616	496	370	291	321	225	143		
15-30	87	41	39	25	29	78	190	343	313	334	376	391	441	497	636	583	618	568	413	337	259	179	119		
30-45	58	44	36	39	30	104	252	358	245	373	414	423	459	518	636	633	612	453	375	316	247	137	94		
45-00	58	37	41	35	36	150	314	400	339	359	406	406	476	504	566	615	589	466	337	310	209	164	92		
TOT	286	180	152	131	142	393	912	1408	1296	1277	1391	1583	1667	1833	2007	2451	2357	2435	1983	1495	1254	1036	705	448	
									AM PEAK HOUR 1100 TO 1200 VOLUME 1583												AM TOTAL 9151				
									PM PEAK HOUR 0430 TO 0530 VOLUME 2482												PM TOTAL 19671				

04/24/15 FRIDAY	AM HOURS												PM HOURS												DAILY TOTAL
	1	2	3	4	5	6	7	8	9	10	11	12	1	2	3	4	5	6	7	8	9	10	11	12	
12	1	2	3	4	5	6	7	8	9	10	11	12	1	2	3	4	5	6	7	8	9	10	11	12	3870
82	53	42	23	29	56	135	305	326																	
15-30	89	49	33	24	89	157	326																		
30-45	75	42	35	34	95	238	375																		
45-00	85	40	35	42	148	332	357																		
TOT	331	184	170	116	129	388	862	1363	327																
									AM PEAK HOUR 0715 TO 0815 VOLUME 1385													AM TOTAL 3870			
									PM PEAK HOUR 0000 TO 0000 VOLUME 0													PM TOTAL 0			

04/20/15 THRU 04/24/15
TOTAL HOURS FOR COUNT 90

3 DAYS
AVG WEEKDAY VOL 28866 X SEASONAL ADJ. FACTOR 0.9400 = 27134 X AXLE CORR FACTOR 0.9810 = ESTIMATED AVG DAILY TRAFFIC 26618

DOT-RNB515A-B

STATE OF WASHINGTON - DEPARTMENT OF TRANSPORTATION
TRIP SYSTEM
15 MINUTE TRAFFIC COUNT SUMMARY

DATE 04/29/15
TIME 10:31:21
PAGE 65

SR 500 MP 005.83 OFF SYSTEM ID.

LEG 2 DIRECTION OF TRAFFIC BOTH WAYS

LANE ALL OF

COUNT IDENTIFIER 15-001 COUNTER NUMBER 175863 DESCRIPTION: ON SR 500 E/O NE GHER RD/YNE 112TR AVE I/C

04/20/15 MONDAY	AM HOURS												PM HOURS												DAILY TOTAL
	1	2	3	4	5	6	7	8	9	10	11	12	1	2	3	4	5	6	7	8	9	10	11	12	
12	1	2	3	4	5	6	7	8	9	10	11	12	1	2	3	4	5	6	7	8	9	10	11	12	27055
00-15																									
15-30																									
30-45																									
45-00																									
HOUR																									
TOT																									27055

AM PEAK HOUR 0000 TO 0000 VOLUME 0
PM PEAK HOUR 0430 TO 0530 VOLUME 4168

AM TOTAL 27055
PM TOTAL 4168

04/21/15 TUESDAY	AM HOURS												PM HOURS												DAILY TOTAL
	1	2	3	4	5	6	7	8	9	10	11	12	1	2	3	4	5	6	7	8	9	10	11	12	
12	1	2	3	4	5	6	7	8	9	10	11	12	1	2	3	4	5	6	7	8	9	10	11	12	57667
00-15																									
15-30																									
30-45																									
45-00																									
HOUR																									
TOT																									57667

AM PEAK HOUR 0715 TO 0815 VOLUME 3799
PM PEAK HOUR 0430 TO 0530 VOLUME 4518

AM TOTAL 23541
PM TOTAL 4518

04/22/15 WEDNESDAY	AM HOURS												PM HOURS												DAILY TOTAL
	1	2	3	4	5	6	7	8	9	10	11	12	1	2	3	4	5	6	7	8	9	10	11	12	
12	1	2	3	4	5	6	7	8	9	10 <td>11</td> <td>12</td> <td>1</td> <td>2</td> <td>3</td> <td>4</td> <td>5</td> <td>6</td> <td>7</td> <td>8</td> <td>9</td> <td>10</td> <td>11</td> <td>12</td> <td>57988</td>	11	12	1	2	3	4	5	6	7	8	9	10	11	12	57988
00-15																									
15-30																									
30-45																									
45-00																									
HOUR																									
TOT																									57988

AM PEAK HOUR 0700 TO 0800 VOLUME 3724
PM PEAK HOUR 0345 TO 0445 VOLUME 4173

AM TOTAL 22958
PM TOTAL 4173

DOT-RNB515A-B

STATE OF WASHINGTON - DEPARTMENT OF TRANSPORTATION
TRIP SYSTEM
15 MINUTE TRAFFIC COUNT SUMMARY

DATE 04/29/15
TIME 10:31:21
PAGE 66

SR 500 MP 005.83 OFF SYSTEM ID. LEG 2 DIRECTION OF TRAFFIC BOTH WAYS LANE ALL OF
COUNT IDENTIFIER 15-001 COUNTER NUMBER 175863 DESCRIPTION: ON SR 500 E/O NE GHER RD/NE 112TH AVE I/C

04/23/15 THURSDAY	AM HOURS												PM HOURS												DAILY TOTAL
	1	2	3	4	5	6	7	8	9	10	11	12	1	2	3	4	5	6	7	8	9	10	11	12	
125	88	66	66	97	294	648	875	817	752	760	788	822	809	875	1014	909	1050	845	660	521	513	378	198	10594	
122	64	64	80	137	380	694	897	880	746	717	804	822	868	880	1065	1043	1037	942	658	556	452	297	175	10594	
87	74	69	109	198	524	799	966	868	706	786	858	821	888	952	1072	1044	1048	805	626	497	377	249	159	10594	
81	61	60	98	225	584	815	991	819	780	806	833	846	888	923	967	1010	1010	815	529	484	328	241	134	10594	
TOT	415	287	259	353	657	1782	2956	3729	3384	2984	3069	3293	3311	3453	3630	4118	4006	4145	3407	2473	2058	1670	1165	666	57270
AM PEAK HOUR 0700 TO 0800 VOLUME 3729												AM TOTAL 23168													
PM PEAK HOUR 0415 TO 0515 VOLUME 4147												PM TOTAL 34102													

04/24/15 FRIDAY	AM HOURS												PM HOURS												DAILY TOTAL
	1	2	3	4	5	6	7	8	9	10	11	12	1	2	3	4	5	6	7	8	9	10	11	12	
104	79	73	52	101	243	576	782	797																10594	
126	79	71	74	110	372	640	864																	10594	
107	62	90	99	182	459	744	939																	10594	
112	64	72	95	194	517	801	914																	10594	
TOT	449	284	306	320	587	1591	2761	3499	797															10594	
AM PEAK HOUR 0715 TO 0815 VOLUME 3514												AM TOTAL 10594													
PM PEAK HOUR 0000 TO 0000 VOLUME 0												PM TOTAL 0													

04/20/15 THRU 04/24/15 TOTAL HOURS FOR COUNT 90

3 DAYS AVG WEEKDAY VOL 57642 X SEASONAL ADJ. FACTOR 0.9400 = 54183 X AXLE CORR FACTOR 0.9810 = ESTIMATED AVG DAILY TRAFFIC 53154

PEAK HOUR PERCENTAGES: K = 7.49 D = 58.24
 PEAK HOUR LOCATION : VOLUME = 4318 DATE: 04/21/15 TIME: 04:30 PM



RU

Interval 60 min. 15 min.
 Binned(CL/SP) Count(volume)
 Lane No 1 2

1 OF 2

Direction Channel 1 _____
 Direction Channel 2 _____
 Unique ID# _____

Counter No. 174648 Count ID 15-001
 SR 500 RRT/RRQ ~~SR 00526~~ MP 5.26
 Leg 1 ~~2~~ Direction WB OSID _____

Station Description ON SR 500 WB ON RAMP FROM NE GHER RD

ON SR 500 W/O NE GHER RD / NE 112TH AVE I/c

Date	Day	Time	Comments
4-20-15	2	1411	Manual (1) <u>1</u> (2) _____ Set Cntrs OK TWB/DB 6.6 Counter (1) <u>1</u> (2) _____
4-21-15	3	1235	Manual (1) <u>50</u> (2) _____ Check Cntrs OK TWB/DB 6.4 Counter (1) <u>50</u> (2) _____
4-22-15	4	0927	Manual (1) <u>50</u> (2) _____ Check Cntrs OK TWB/DB 7.0 Counter (1) <u>50</u> (2) _____
4-23-15	5	1041	Manual (1) <u>50</u> (2) _____ Check Cntrs OK TWB/DB 7.0 Counter (1) <u>50</u> (2) _____
4-24-15	6	0832	Manual (1) <u>1</u> (2) _____ P/U Cntrs OK TWB/DB 6.6 Counter (1) <u>1</u> (2) _____

Sketch

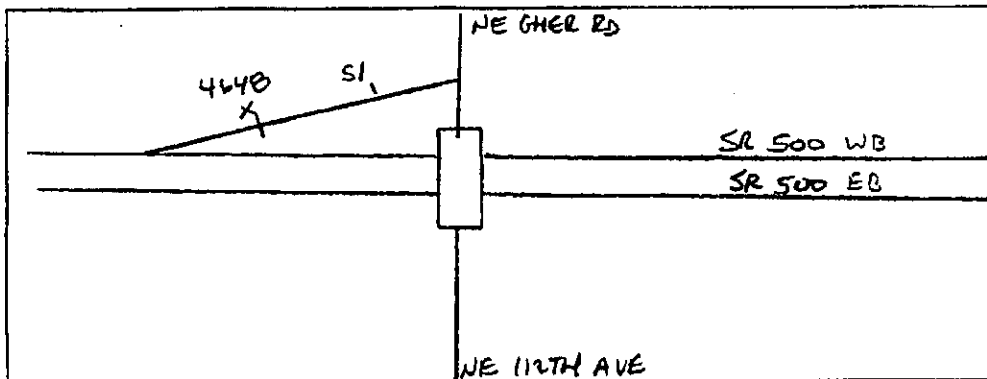

T BREUER
Field Person



Washington State
Department of Transportation

RU

Diamond Traffic Counter

Interval 60 min. 15 min.
 Binned(CL/SP) Count(volume)
Lane No 1 2

Direction Channel 1 MAINLINE WB *2 OF 2*
Direction Channel 2 ~~R1-00579~~ U
Unique ID# _____

Counter No. 172315 Count ID 15-001
SR 500 RRT/RRQ MP 5.26
Leg 1 ~~2~~ Direction See 1,2 OSID _____

Station Description ON SR 500 W/O NE GHER RD/NE 112TH AVE I/C

Date	Day	Time	Comments				
4-20-15	2	1356	Manual (1) 1 (2) 1 Counter (1) 1 (2) 1	Set Cntrs	OK	TWB/DB	6.5
4-21-15	3	1227	Manual (1) 50 (2) 8 Counter (1) 50 (2) 8	Check Cntrs	OK	TWB/DB	6.8
4-22-15	4	0923	Manual (1) 50 (2) 7 Counter (1) 50 (2) 7	Check Cntrs	OK	TWB/DB	6.9
4-23-15	5	1035	Manual (1) 50 (2) 7 Counter (1) 50 (2) 7	Check Cntrs	OK	TWB/DB	7.2
4-24-15	6	0827	Manual (1) 1 (2) _____ Counter (1) 1 (2) _____	P/U Cntrs	OK	TWB/DB	6.5

Sketch

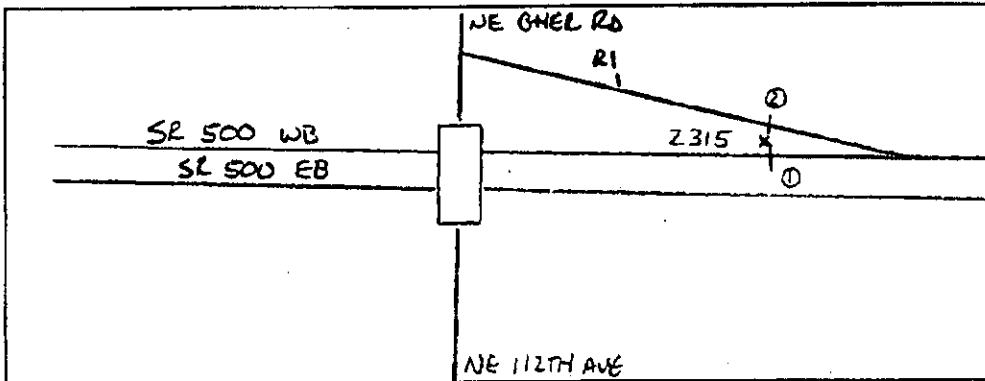

T. BRECKEN
Field Person



RU

Interval 60 min. 15 min.
 Binned(CL/SP) Count(volume)
Lane No 1 2

Direction Channel 1 MAINLINE EB
Direction Channel 2 ~~Q1 00583~~ U
Unique ID# _____

Counter No. 175863 Count ID 15-001
SR 500 RRT/RRQ MP 5.26
Leg 1 ~~2~~ Direction See 1,2 OSID _____

Station Description ON SR 500 W/O NE GHER RD/NE 112TH AVE I/C

Date	Day	Time	Comments				
4-20-15	2	1311	Manual (1) 1 (2) 1 Counter (1) 1 (2) 1	Set Cntrs	OK	TWB/DB	6.4
4-21-15	3	1215	Manual (1) 50 (2) 15 Counter (1) 50 (2) 15	Check Cntrs	OK	TWB/DB	6.9
4-22-15	4	0917	Manual (1) 50 (2) 5 Counter (1) 50 (2) 5	Check Cntrs	OK	TWB/DB	6.9
4-23-15	5	1028	Manual (1) 50 (2) 5 Counter (1) 50 (2) 5	Check Cntrs	OK	TWB/DB	7.0
4-24-15	6	0820	Manual (1) 1 (2) _____ Counter (1) 1 (2) _____	P/U Cntrs	OK	TWB/DB	6.5

Sketch

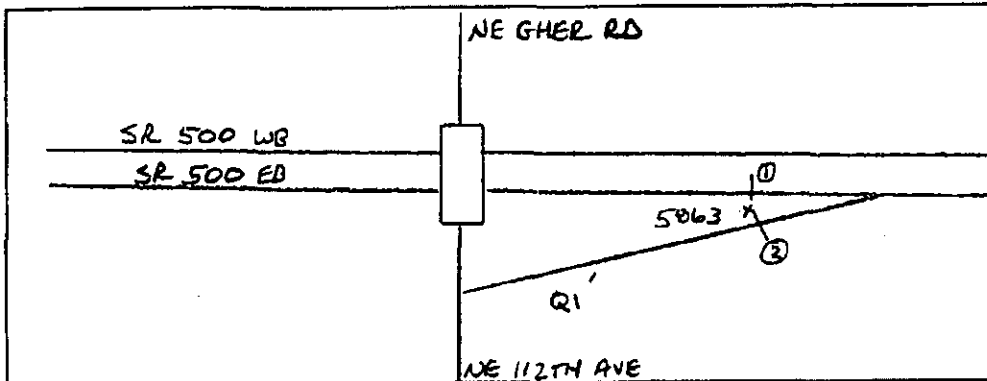

North

T BREUCEL
Field Person

DOT-RNBS15A-B

STATE OF WASHINGTON - DEPARTMENT OF TRANSPORTATION
TRIP SYSTEM
15 MINUTE TRAFFIC COUNT SUMMARY

DATE 04/29/15
TIME 10:31:21
PAGE 43

SR 500 MP 005.26 OFF SYSTEM ID. LEG 1 DIRECTION OF TRAFFIC WESTBOUND LANE 1 OF 2

COUNT IDENTIFIER 15-001 COUNTER NUMBER 174648 DESCRIPTION: ON SR 500 W/O NE GHER RD/NE 112TH AVE I/C

COUNT	IDENTIFIER	04/20/15 MONDAY												DAILY TOTAL
		AM HOURS						PM HOURS						
		1	2	3	4	5	6	7	8	9	10	11	12	
00-15	12	1	2	3	4	5	6	7	8	9	10	11	12	84
15-30	1	2	3	4	5	6	7	8	9	10	11	12	85	
30-45	1	2	3	4	5	6	7	8	9	10	11	12	58	
45-00	1	2	3	4	5	6	7	8	9	10	11	12	24	
TOT		12	12	12	12	12	12	12	12	12	12	12	7337	
		AM PEAK HOUR 0000 TO 0000 VOLUME 0						PM PEAK HOUR 0445 TO 0545 VOLUME 1272						AM TOTAL 0
		PM PEAK HOUR 0445 TO 0545 VOLUME 1272						AM PEAK HOUR 0000 TO 0000 VOLUME 0						PM TOTAL 7337

COUNT	IDENTIFIER	04/21/15 TUESDAY												DAILY TOTAL
		AM HOURS						PM HOURS						
		1	2	3	4	5	6	7	8	9	10	11	12	
00-15	12	1	2	3	4	5	6	7	8	9	10	11	12	69
15-30	1	2	3	4	5	6	7	8	9	10	11	12	52	
30-45	1	2	3	4	5	6	7	8	9	10	11	12	36	
45-00	1	2	3	4	5	6	7	8	9	10	11	12	45	
TOT		12	12	12	12	12	12	12	12	12	12	12	17593	
		AM PEAK HOUR 0715 TO 0815 VOLUME 1373						PM PEAK HOUR 0445 TO 0545 VOLUME 1285						AM TOTAL 7980
		PM PEAK HOUR 0445 TO 0545 VOLUME 1285						AM PEAK HOUR 0715 TO 0815 VOLUME 1373						PM TOTAL 9613

COUNT	IDENTIFIER	04/22/15 WEDNESDAY												DAILY TOTAL
		AM HOURS						PM HOURS						
		1	2	3	4	5	6	7	8	9	10	11	12	
00-15	12	1	2	3	4	5	6	7	8	9	10	11	12	93
15-30	1	2	3	4	5	6	7	8	9	10	11	12	50	
30-45	1	2	3	4	5	6	7	8	9	10	11	12	43	
45-00	1	2	3	4	5	6	7	8	9	10	11	12	21	
TOT		12	12	12	12	12	12	12	12	12	12	12	18027	
		AM PEAK HOUR 0715 TO 0815 VOLUME 1390						PM PEAK HOUR 0445 TO 0545 VOLUME 1235						AM TOTAL 8094
		PM PEAK HOUR 0445 TO 0545 VOLUME 1235						AM PEAK HOUR 0715 TO 0815 VOLUME 1390						PM TOTAL 9933

DOT-RNB515A-B

STATE OF WASHINGTON - DEPARTMENT OF TRANSPORTATION
TRIP SUMMARY
15 MINUTE TRAFFIC COUNT SUMMARY

DATE 04/29/15
TIME 10:31:21
PAGE 44

SR 500 MP 005.26 OFF SYSTEM ID. LEG 1 DIRECTION OF TRAFFIC WESTBOUND LANE 1 OF 2

COUNT IDENTIFIER 15-001 COUNTER NUMBER 174648 DESCRIPTION: ON SR 500 W/O NE GHER RD/NE 112TH AVE I/C

04/23/15 THURSDAY	AM HOURS												PM HOURS												DAILY TOTAL
	1	2	3	4	5	6	7	8	9	10	11	12	1	2	3	4	5	6	7	8	9	10	11	12	
00-15	19	17	19	18	42	131	298	339	297	256	247	252	240	210	242	297	287	352	276	208	133	113	97	47	
15-30	13	19	21	21	65	148	291	320	302	313	231	279	265	246	199	273	271	280	250	166	142	118	67	45	
30-45	17	22	29	37	79	215	330	341	315	269	260	250	248	234	311	267	336	302	248	142	127	103	58	38	
45-00	14	16	15	27	73	210	282	377	282	271	241	258	276	266	245	302	314	296	217	154	112	78	52	36	
TOT	63	74	84	103	259	704	1201	1377	1196	1109	979	1039	1029	956	997	1139	1208	1230	991	670	514	412	274	166	17774

AM PEAK HOUR 0700 TO 0800 VOLUME 1377
PM PEAK HOUR 0430 TO 0530 VOLUME 1282

AM TOTAL 8188
PM TOTAL 9586

04/24/15 FRIDAY	AM HOURS												PM HOURS												DAILY TOTAL
	1	2	3	4	5	6	7	8	9	10	11	12	1	2	3	4	5	6	7	8	9	10	11	12	
00-15	28	16	20	17	35	113	256	283	297	256	247	252	240	210	242	297	287	352	276	208	133	113	97	47	
15-30	17	19	12	12	60	150	284	302	302	313	231	279	265	246	199	273	271	280	250	166	142	118	67	45	
30-45	22	20	26	36	77	192	281	351	315	269	260	250	248	234	311	267	336	302	248	142	127	103	58	38	
45-00	17	15	14	29	62	183	285	317	282	271	241	258	276	266	245	302	314	296	217	154	112	78	52	36	
TOT	84	70	72	114	234	638	1106	1253	626	626	412	412	274	166	17774	4197	4197	4197	4197	4197	4197	4197	4197	4197	4197

AM PEAK HOUR 0730 TO 0830 VOLUME 1294
PM PEAK HOUR 0000 TO 0000 VOLUME 0

AM TOTAL 4197
PM TOTAL 0

SR 500 MP 005.26 OFF SYSTEM ID. LEG 1 DIRECTION OF TRAFFIC WESTBOUND LANE 2 OF 2
 COUNT IDENTIFIER 15-001 COUNTER NUMBER 172315 * DESCRIPTION: ON SR 500 W/O NE GHER RD/NE 112TH AVE I/C

04/20/15 MONDAY AM HOURS PM HOURS

00-15	12	1	2	3	4	5	6	7	8	9	10	11	12	DAILY
15-30	1	2	3	4	5	6	7	8	9	10	11	12	TOTAL	
30-45	1	2	3	4	5	6	7	8	9	10	11	12	TOTAL	
45-00	1	2	3	4	5	6	7	8	9	10	11	12	TOTAL	
HOUR	12	1	2	3	4	5	6	7	8	9	10	11	12	DAILY
TOT	1472	1508	1401	1503	1203	823	737	567	401	227	9842			

AM PEAK HOUR 0000 TO 0000 VOLUME 0
 PM PEAK HOUR 0415 TO 0515 VOLUME 1549

04/21/15 TUESDAY AM HOURS PM HOURS

00-15	12	1	2	3	4	5	6	7	8	9	10	11	12	DAILY											
15-30	1	2	3	4	5	6	7	8	9	10	11	12	TOTAL												
30-45	1	2	3	4	5	6	7	8	9	10	11	12	TOTAL												
45-00	1	2	3	4	5	6	7	8	9	10	11	12	TOTAL												
HOUR	127	118	137	220	534	1350	1970	2147	1924	1631	1493	1416	1401	1411	1448	1493	1539	1510	1276	919	656	530	371	208	25829
TOT	127	118	137	220	534	1350	1970	2147	1924	1631	1493	1416	1401	1411	1448	1493	1539	1510	1276	919	656	530	371	208	25829

AM PEAK HOUR 0700 TO 0800 VOLUME 2147
 PM PEAK HOUR 0445 TO 0545 VOLUME 1575

04/22/15 WEDNESDAY AM HOURS PM HOURS

00-15	12	1	2	3	4	5	6	7	8	9	10	11	12	DAILY											
15-30	1	2	3	4	5	6	7	8	9	10	11	12	TOTAL												
30-45	1	2	3	4	5	6	7	8	9	10	11	12	TOTAL												
45-00	1	2	3	4	5	6	7	8	9	10	11	12	TOTAL												
HOUR	138	91	110	196	499	1350	1921	2154	1802	1649	1517	1401	1537	1534	1499	1504	1493	1461	1245	932	772	561	378	216	25960
TOT	138	91	110	196	499	1350	1921	2154	1802	1649	1517	1401	1537	1534	1499	1504	1493	1461	1245	932	772	561	378	216	25960

AM PEAK HOUR 0700 TO 0800 VOLUME 2154
 PM PEAK HOUR 1245 TO 0145 VOLUME 1551

SR 500 MP 005.26 OFF SYSTEM ID. LEG 1 DIRECTION OF TRAFFIC WESTBOUND LANE 2 OF 2

COUNT IDENTIFIER 15-001 COUNTER NUMBER 172315 * DESCRIPTION: ON SR 500 W/O NE GIER RD/NE 112TH AVE I/C

04/23/15 THURSDAY	AM HOURS												PM HOURS												DAILY TOTAL
	1	2	3	4	5	6	7	8	9	10	11	12	1	2	3	4	5	6	7	8	9	10	11	12	
12	1	2	3	4	5	6	7	8	9	10	11	12	1	2	3	4	5	6	7	8	9	10	11	12	1288
1	2	3	4	5	6	7	8	9	10	11	12	1	2	3	4	5	6	7	8	9	10	11	12	12648	
38	27	26	32	69	224	472	527	474	350	395	366	332	312	345	343	332	373	301	248	198	162	136	49	49	
15-30	20	23	50	106	281	483	506	513	395	348	388	379	386	336	388	407	370	323	220	191	168	103	49	49	
30-45	26	28	67	164	404	516	557	475	409	373	409	350	387	392	381	356	367	304	215	140	111	92	60	60	
45-00	22	23	19	59	160	402	459	429	403	401	389	399	360	367	361	343	369	304	161	155	95	70	38	38	
TOT	112	98	100	208	499	1311	1930	2113	1891	1557	1517	1552	1460	1445	1440	1493	1438	1479	1232	844	684	536	401	196	25536

AM PEAK HOUR 0700 TO 0800 VOLUME 2113
 PM PEAK HOUR 0230 TO 0330 VOLUME 1510

04/24/15 FRIDAY	AM HOURS												PM HOURS												DAILY TOTAL
	1	2	3	4	5	6	7	8	9	10	11	12	1	2	3	4	5	6	7	8	9	10	11	12	
12	1	2	3	4	5	6	7	8	9	10	11	12	1	2	3	4	5	6 <td>7</td> <td>8</td> <td>9</td> <td>10</td> <td>11</td> <td>12</td> <td>1936</td>	7	8	9	10	11	12	1936
1	2	3	4	5	6	7	8	9	10	11	12	1	2	3	4	5	6 <td>7</td> <td>8</td> <td>9</td> <td>10</td> <td>11</td> <td>12</td> <td>6237</td>	7	8	9	10	11	12	6237	
19	23	28	24	69	178	424	450	420	350	379	366	332	312	345	343	332	373	301	248	198	162	136	49	49	
15-30	34	26	37	85	258	461	488	474	395	348	388	379	386	336	388	407	370	323	220	191	168	103	49	49	
30-45	29	18	34	61	146	350	485	501	409	373	409	350	387	392	381	356	367	304	215	140	111	92	60	60	
45-00	18	23	25	57	146	344	430	497	403	401	389	399	360	367	361	343	369	304	161	155	95	70	38	38	
TOT	100	90	124	191	446	1130	1800	1936	1891	1557	1517	1552	1460	1445	1440	1493	1438	1479	1232	844	684	536	401	196	6237

AM PEAK HOUR 0700 TO 0800 VOLUME 1936
 PM PEAK HOUR 0000 TO 0000 VOLUME 0

DOT-RN8515A-8

STATE OF WASHINGTON - DEPARTMENT OF TRANSPORTATION
TRIPSSYSTEM
15 MINUTE TRAFFIC COUNT SUMMARY

DATE 04/29/15
TIME 10:31:21
PAGE 47

SR 500 MP 005.26 OFF SYSTEM ID. LEG 1 DIRECTION OF TRAFFIC WESTBOUND LANE 12 OF 2

COUNT IDENTIFIER 15-001 COUNTER NUMBER 172315 * DESCRIPTION: ON SR 500 W/O NE GHER RD/NE 112TH AVE I/C

04/20/15 MONDAY		AM HOURS												PM HOURS												DAILY TOTAL	
TIME	COUNT	1	2	3	4	5	6	7	8	9	10	11	12	1	2	3	4	5	6	7	8	9	10	11	12	TOTAL	TOTAL
00-15	12	1	2	3	4	5	6	7	8	9	10	11	12	1	2	3	4	5	6	7	8	9	10	11	12	1902	2613
15-30	1	2	3	4	5	6	7	8	9	10	11	12	1	2	3	4	5	6	7	8	9	10	11	12	665	596	
30-45	1	2	3	4	5	6	7	8	9	10	11	12	1	2	3	4	5	6	7	8	9	10	11	12	614	672	
45-00	1	2	3	4	5	6	7	8	9	10	11	12	1	2	3	4	5	6	7	8	9	10	11	12	595	646	
TOT	216	137	183	306	772	2060	3130	3521	5018	2750	2482	2347	2540	2573	2619	2637	2688	2636	2242	1634	1371	1079	669	377	43987		

AM PEAK HOUR 0000 TO 0000 VOLUME 0
PM PEAK HOUR 0415 TO 0515 VOLUME 2818

AM TOTAL 0
PM TOTAL 16810

04/21/15 TUESDAY		AM HOURS												PM HOURS												DAILY TOTAL	
TIME	COUNT	1	2	3	4	5	6	7	8	9	10	11	12	1	2	3	4	5	6	7	8	9	10	11	12	TOTAL	TOTAL
00-15	12	1	2	3	4	5	6	7	8	9	10	11	12	1	2	3	4	5	6	7	8	9	10	11	12	219	181
15-30	1	2	3	4	5	6	7	8	9	10	11	12	1	2	3	4	5	6	7	8	9	10	11	12	854	653	
30-45	1	2	3	4	5	6	7	8	9	10	11	12	1	2	3	4	5	6	7	8	9	10	11	12	807	675	
45-00	1	2	3	4	5	6	7	8	9	10	11	12	1	2	3	4	5	6	7	8	9	10	11	12	773	704	
TOT	219	181	212	332	811	2050	3153	3440	5182	2700	2407	2360	2340	2329	2511	2641	2737	2721	2294	1618	1216	975	622	371	43422		

AM PEAK HOUR 0715 TO 0815 VOLUME 3499
PM PEAK HOUR 0445 TO 0545 VOLUME 2860

AM TOTAL 21067
PM TOTAL 22375

04/22/15 WEDNESDAY		AM HOURS												PM HOURS												DAILY TOTAL	
TIME	COUNT	1	2	3	4	5	6	7	8	9	10	11	12	1	2	3	4	5	6	7	8	9	10	11	12	TOTAL	TOTAL
00-15	12	1	2	3	4	5	6	7	8	9	10	11	12	1	2	3	4	5	6	7	8	9	10	11	12	216	137
15-30	1	2	3	4	5	6	7	8	9	10	11	12	1	2	3	4	5	6	7	8	9	10	11	12	69	45	
30-45	1	2	3	4	5	6	7	8	9	10	11	12	1	2	3	4	5	6	7	8	9	10	11	12	53	37	
45-00	1	2	3	4	5	6	7	8	9	10	11	12	1	2	3	4	5	6	7	8	9	10	11	12	53	32	
TOT	216	137	183	306	772	2060	3130	3521	5018	2750	2482	2347	2540	2573	2619	2637	2688	2636	2242	1634	1371	1079	669	377	43987		

AM PEAK HOUR 0715 TO 0815 VOLUME 3525
PM PEAK HOUR 0430 TO 0530 VOLUME 2752

AM TOTAL 20922
PM TOTAL 23065

SR 500 MP 005.26 OFF SYSTEM ID. LEG 1 DIRECTION OF TRAFFIC WESTBOUND LANE 12 OF 2

COUNT IDENTIFIER	15-001	COUNTER NUMBER	172315 *	DESCRIPTION: ON SR 500 W/O NE GHER RD/NE 112TH AVE 1/C
04/23/15 THURSDAY				
	12	1	2	3
	1	2	3	4
	2	3	4	5
	3	4	5	6
	4	5	6	7
	5	6	7	8
	6	7	8	9
	7	8	9	10
	8	9	10	11
	9	10	11	12
	10	11	12	TOTAL
	11	12	TOTAL	DAILY
	12	TOTAL	AM TOTAL	21076
	TOTAL	AM HOURS	PM HOURS	PM TOTAL
	175	172	184	311
	758	2015	3131	3490
	2666	2496	2591	2489
	2401	2437	2632	2646
	2709	2223	1514	1198
	948	675	362	43310

04/24/15 FRIDAY	1	2	3	4	5	6	7	8	9	10	11	12	TOTAL
00-15	47	39	48	41	104	291	680	733	726				
15-30	51	45	49	81	145	408	745	790					
30-45	51	38	60	97	223	542	766	852					
45-00	35	38	39	86	208	527	715	814					
HOUR	184	160	196	305	680	1768	2906	3189	726				10114
TOT													

04/20/15 THRU 04/24/15 TOTAL HOURS FOR COUNT 89
 3 DAYS AVG WEEKDAY VOL 43573 X SEASONAL ADJ. FACTOR 0.9400 = 40959 X AXLE CORR FACTOR 0.9810 = ESTIMATED AVG DAILY TRAFFIC 40181
 FACTOR GROUP GR-02
 FACTOR GROUP GR-B2

AM PEAK HOUR 0700 TO 0800 VOLUME	3189	PM PEAK HOUR 0415 TO 0515 VOLUME	2752	AM TOTAL	10114	PM TOTAL	0
AM PEAK HOUR 0700 TO 0800 VOLUME	3189	PM PEAK HOUR 0415 TO 0515 VOLUME	2752	AM TOTAL	10114	PM TOTAL	0

SR 500 MP 005.26 OFF SYSTEM ID. LEG 1 DIRECTION OF TRAFFIC EASTBOUND LANE ALL OF

COUNT IDENTIFIER 15-001 COUNTER NUMBER 175863 DESCRIPTION: ON SR 500 W/O NE GHER RD/NE 112TH AVE I/C

04/20/15 MONDAY	AM HOURS												PM HOURS												DAILY TOTAL
	1	2	3	4	5	6	7	8	9	10	11	12	1	2	3	4	5	6	7	8	9	10	11	12	
12	1	2	3	4	5	6	7	8	9	10	11	12	1	2	3	4	5	6	7	8	9	10	11	12	15240
00-15																									104
15-30																									116
30-45																									109
45-00																									96
HOUR																									
TOT	1149	1843	2115	2146	2122	1657	1213	1027	953	590	425	15240													

AM PEAK HOUR 0000 TO 0000 VOLUME 0
 PM PEAK HOUR 0430 TO 0530 VOLUME 2179

AM TOTAL 15240
 PM TOTAL 0

04/21/15 TUESDAY	AM HOURS												PM HOURS												DAILY TOTAL
	1	2	3	4	5	6	7	8	9	10	11	12	1	2	3	4	5	6	7	8	9	10	11	12	
12	1	2	3	4	5	6	7	8	9	10	11	12	1	2	3	4	5	6	7	8	9	10	11	12	25544
00-15	79	63	45	31	27	60	127	237	259	286	276	317	338	392	393	503	541	579	526	374	275	296	176	108	
15-30	63	46	39	36	70	179	329	284	260	284	300	374	367	466	528	570	563	452	317	304	257	149	127	108	
30-45	51	37	41	28	36	98	217	317	276	267	317	327	335	429	419	586	554	513	411	316	279	230	135	111	
45-00	47	31	46	43	52	119	302	362	336	278	291	336	403	378	487	561	564	489	415	307	267	186	124	84	
HOUR																									
TOT	240	177	171	138	149	347	825	1245	1155	1091	1168	1280	1450	1566	1765	2178	2229	2144	1804	1314	1125	969	584	430	

AM PEAK HOUR 1100 TO 1200 VOLUME 1280
 PM PEAK HOUR 0415 TO 0515 VOLUME 2267

AM TOTAL 7986
 PM TOTAL 17558

04/22/15 WEDNESDAY	AM HOURS												PM HOURS												DAILY TOTAL
	1	2	3	4	5	6	7	8	9	10	11	12	1	2	3	4	5	6	7	8	9	10	11	12	
12	1	2	3	4	5	6	7	8	9	10	11	12	1	2	3	4	5	6	7	8	9	10	11	12	25659
00-15	65	49	39	21	21	50	130	247	241	292	281	321	376	413	405	489	556	542	456	355	318	268	167	134	
15-30	82	35	35	30	28	73	160	316	319	263	285	307	391	438	439	525	542	564	499	380	273	257	164	120	
30-45	57	41	39	22	34	82	203	317	323	269	319	332	392	371	458	543	563	527	427	326	291	273	169	107	
45-00	58	36	29	28	39	149	276	314	291	290	283	336	377	400	539	527	565	508	380	311	289	195	130	63	
HOUR																									
TOT	262	161	142	101	122	354	769	1194	1174	1114	1168	1296	1536	1622	1841	2084	2226	2141	1762	1372	1171	993	630	424	

AM PEAK HOUR 1100 TO 1200 VOLUME 1296
 PM PEAK HOUR 0430 TO 0530 VOLUME 2234

AM TOTAL 7857
 PM TOTAL 17802

DOT-RNB515A-B

STATE OF WASHINGTON - DEPARTMENT OF TRANSPORTATION
TRIP SYSTEM
15 MINUTE TRAFFIC COUNT SUMMARY

DATE 04/29/15
TIME 10:31:21
PAGE 50

SR 500 MP 005.26 OFF SYSTEM ID. LEG 1 DIRECTION OF TRAFFIC EASTBOUND LANE ALL OF
COUNT IDENTIFIER 15-001 COUNTER NUMBER 175863 DESCRIPTION: ON SR 500 W/O NE GHER RD/NE 112TH AVE I/C

04/23/15 THURSDAY	AM HOURS												PM HOURS												DAILY TOTAL
	1	2	3	4	5	6	7	8	9	10	11	12	1	2	3	4	5	6	7	8	9	10	11	12	
12	1	2	3	4	5	6	7	8	9	10	11	12	1	2	3	4	5	6	7	8	9	10	11	12	25585
TOT	266	160	136	116	128	354	816	1229	1133	1113	1208	1408	1448	1610	1774	2196	2073	2194	1767	1318	1133	942	646	417	

AM PEAK HOUR 1100 TO 1200 VOLUME 1408
PM PEAK HOUR 0430 TO 0530 VOLUME 2202

AM TOTAL 8067
PM TOTAL 17518

04/24/15 FRIDAY	AM HOURS												PM HOURS												DAILY TOTAL
	1	2	3	4	5	6	7	8	9	10	11	12	1	2	3	4	5	6	7	8	9	10	11	12	
12	1	2	3	4	5	6	7	8	9	10	11	12	1	2	3	4	5	6	7	8	9	10	11	12	3442
TOT	303	169	162	106	117	343	767	1188	287																

AM PEAK HOUR 0715 TO 0815 VOLUME 1201
PM PEAK HOUR 0000 TO 0000 VOLUME 0

AM TOTAL 3442
PM TOTAL 0

04/20/15 THRU 04/24/15
TOTAL HOURS FOR COUNT 90

3 DAYS
AVG WEEKDAY VOL 25596 X SEASONAL ADJ. FACTOR 0.9400 = 24060 X AXLE CORR FACTOR 0.9810 = ESTIMATED AVG DAILY TRAFFIC 23603

FACTOR GROUP GR-02

FACTOR GROUP GR-B2

SR 500 MP 005.26 OFF SYSTEM ID. LEG 1 DIRECTION OF TRAFFIC BOTH WAYS LANE ALL OF

COUNT IDENTIFIER 15-001 COUNTER NUMBER 175863 DESCRIPTION: ON SR 500 W/O NE GHER RD/NE 112TH AVE I/C

COUNT IDENTIFIER	04/20/15 MONDAY												DAILY TOTAL												
	AM HOURS																								
	1	2	3	4	5	6	7	8	9	10	11	12													
00-15	12	1	2	3	4	5	6	7	8	9	10	11	12	1166											
15-30	1	2	3	4	5	6	7	8	9	10	11	12	1084												
30-45	1	2	3	4	5	6	7	8	9	10	11	12	1086												
45-00	1	2	3	4	5	6	7	8	9	10	11	12	1167												
HOUR																									
TOT	478	298	325	407	894	2414	3899	4715	4192	3864	3650	3643	4076	4195	4460	4721	4914	4777	4004	3006	2542	2072	1299	801	69646

AM PEAK HOUR 0000 TO 0000 VOLUME 0
 PM PEAK HOUR 0430 TO 0530 VOLUME 4972
 AM TOTAL 30493
 PM TOTAL 0

COUNT IDENTIFIER	04/21/15 TUESDAY												DAILY TOTAL												
	AM HOURS																								
	1	2	3	4	5	6	7	8	9	10	11	12													
00-15	12	1	2	3	4	5	6	7	8	9	10	11	12	1166											
15-30	1	2	3	4	5	6	7	8	9	10	11	12	1084												
30-45	1	2	3	4	5	6	7	8	9	10	11	12	1086												
45-00	1	2	3	4	5	6	7	8	9	10	11	12	1167												
HOUR																									
TOT	459	358	383	470	960	2397	3978	4685	4337	3791	3575	3640	3790	3895	4276	4819	4966	4865	4098	2932	2341	1944	1206	801	68966

AM PEAK HOUR 0715 TO 0815 VOLUME 4766
 PM PEAK HOUR 0430 TO 0530 VOLUME 5101
 AM TOTAL 29033
 PM TOTAL 39933

COUNT IDENTIFIER	04/22/15 WEDNESDAY												DAILY TOTAL												
	AM HOURS																								
	1	2	3	4	5	6	7	8	9	10	11	12													
00-15	12	1	2	3	4	5	6	7	8	9	10	11	12	1166											
15-30	1	2	3	4	5	6	7	8	9	10	11	12	1084												
30-45	1	2	3	4	5	6	7	8	9	10	11	12	1086												
45-00	1	2	3	4	5	6	7	8	9	10	11	12	1167												
HOUR																									
TOT	478	298	325	407	894	2414	3899	4715	4192	3864	3650	3643	4076	4195	4460	4721	4914	4777	4004	3006	2542	2072	1299	801	69646

AM PEAK HOUR 0700 TO 0800 VOLUME 4715
 PM PEAK HOUR 0430 TO 0530 VOLUME 4986
 AM TOTAL 28779
 PM TOTAL 40867

SR 500 MP 005.26 OFF SYSTEM I.D. LEG 1 DIRECTION OF TRAFFIC BOTH WAYS LANE ALL OF

COUNT IDENTIFIER 15-001 COUNTER NUMBER 175863 DESCRIPTION: ON SR 500 W/O NE GHER RD/NE 112TH AVE I/C

04/23/15 THURSDAY	AM HOURS												PM HOURS												DAILY TOTAL
	1	2	3	4	5	6	7	8	9	10	11	12	1	2	3	4	5	6	7	8	9	10	11	12	
12	1	2	3	4	5	6	7	8	9	10	11	12	1	2	3	4	5	6	7	8	9	10	11	12	133
15-30	123	74	76	92	196	502	947	1123	1100	988	877	1006	974	1023	975	1237	1188	1200	1095	742	626	527	336	209	
30-45	94	86	94	140	270	713	1078	1202	1093	897	969	1018	974	1018	1160	1209	1250	1224	952	696	555	435	275	180	
45-00	91	72	70	116	283	745	1014	1251	987	974	954	1006	1029	1044	1053	1169	1198	1201	916	611	551	366	276	160	
TOT	441	332	320	427	886	2369	3947	4719	4220	3779	3704	3999	3937	4011	4211	4828	4719	4903	3990	2832	2331	1890	1321	779	
									AM PEAK HOUR 0700 TO 0800 VOLUME 4719													AM TOTAL 29143			
									PM PEAK HOUR 0430 TO 0530 VOLUME 4926													PM TOTAL 39752			

04/24/15 FRIDAY	AM HOURS												PM HOURS												DAILY TOTAL
	1	2	3	4	5	6	7	8	9	10	11	12	1	2	3	4	5	6	7	8	9	10	11	12	
12	1	2	3	4	5	6	7	8	9	10 <td>11</td> <td>12</td> <td>1</td> <td>2</td> <td>3</td> <td>4</td> <td>5</td> <td>6</td> <td>7</td> <td>8</td> <td>9</td> <td>10</td> <td>11</td> <td>12</td> <td>120</td>	11	12	1	2	3	4	5	6	7	8	9	10	11	12	120
15-30	135	92	80	101	168	487	882	1070	131	344	796	1007	1013	1013	1013	1013	1013	1013	1013	1013	1013	1013	1013	1013	
30-45	118	74	112	129	253	622	984	1177	80	119	245	658	1011	1123	1013	1013	1013	1013	1013	1013	1013	1013	1013	1013	
45-00	114	75	80	119	245	658	1011	1123	80	119	245	658	1011	1123	1013	1013	1013	1013	1013	1013	1013	1013	1013	1013	
TOT	487	329	358	411	797	2111	3673	4377	1013	1013	1013	1013	1013	1013	1013	1013	1013	1013	1013	1013	1013	1013	1013		
									AM PEAK HOUR 0715 TO 0815 VOLUME 4383													AM TOTAL 13556			
									PM PEAK HOUR 0000 TO 0000 VOLUME 0													PM TOTAL 0			

04/20/15 THRU 04/24/15 TOTAL HOURS FOR COUNT 89

3 DAYS AVG WEEKDAY VOL 69169 X SEASONAL ADJ. FACTOR 0.9400 = 65019 X AXLE CORR FACTOR 0.9810 = ESTIMATED AVG DAILY TRAFFIC 63784

PEAK HOUR PERCENTAGES: K = 7.37 O = 55.69
 PEAK HOUR LOCATION : VOLUME = 5101 DATE: 04/21/15 TIME: 04:30 PM



PU

Interval 60 min. 15 min.
 Binned(CL/SP) Count(volume)
Lane No 1 2

Direction Channel 1 _____
Direction Channel 2 _____
Unique ID# _____

Counter No. 178693 Count ID 15 001
SR 500 RRT/RRQ P1 00480 MP 0.04
~~0.00~~
Leg 2 Direction EB OSID _____

Station Description ON SR 500 EB OFF RAMP TO NE 112TH AVE

Date	Day	Time	Comments
4/20/15	2	1446	Manual (1) <u>1</u> (2) _____ Counter (1) <u>1</u> (2) _____ SET COUNTER OK DB/TWB
4/21	3	1312	Manual (1) <u>35</u> (2) _____ Counter (1) <u>35</u> (2) _____ CHECK COUNTER OK
4/22	4	0938	Manual (1) <u>8</u> (2) _____ Counter (1) <u>8</u> (2) _____ CHECK COUNTER OK
4/23	5	1100	Manual (1) <u>42</u> (2) _____ Counter (1) <u>42</u> (2) _____ CHECK COUNTER OK
4/24	6	0851	Manual (1) <u>1</u> (2) _____ Counter (1) <u>1</u> (2) _____ P/U COUNTER OK DB/TWB

Sketch

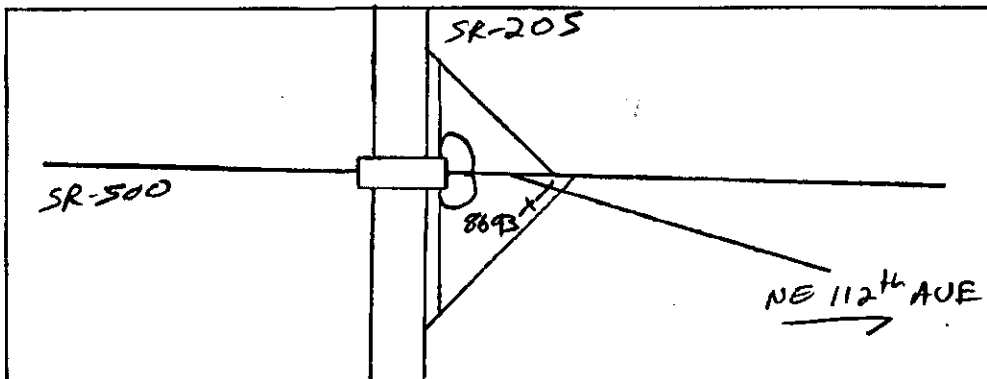

Field Person _____

SR 500 P100480 MP 000.04 OFF SYSTEM ID. LEG 2 DIRECTION OF TRAFFIC EASTBOUND LANE ALL OF
 COUNT IDENTIFIER 15-001 COUNTER NUMBER 178693 DESCRIPTION: ON SR 500 EB OFF RAMP TO NE 112TH AVE

04/20/15 MONDAY	AM HOURS												PM HOURS												DAILY TOTAL	
	1	2	3	4	5	6	7	8	9	10	11	12	1	2	3	4	5	6	7	8	9	10	11	12		
12	1	2	3	4	5	6	7	8	9	10	11	12	1	2	3	4	5	6	7	8	9	10	11	12	190	
15-30	21	18	16	16	11	44	77	167	142	104	137	165	169	176	172	202	196	192	247	267	215	156	135	136	84	55
30-45	22	14	15	15	11	48	92	188	149	110	105	140	154	149	181	172	172	224	239	323	218	162	112	116	71	55
45-00	15	11	16	14	20	74	140	182	166	132	130	156	174	182	175	175	229	241	228	207	153	134	78	50	38	
TOT	89	54	56	34	43	197	379	659	621	475	479	635	659	709	724	875	994	1101	856	609	518	439	260	180	11643	

AM PEAK HOUR 0000 TO 0000 VOLUME 0
 PM PEAK HOUR 0430 TO 0530 VOLUME 1025

04/21/15 TUESDAY	AM HOURS												PM HOURS												DAILY TOTAL
	1	2	3	4	5	6	7	8	9	10	11	12	1	2	3	4	5	6	7	8	9	10	11	12	
12	1	2	3	4	5	6	7	8	9	10	11	12	1	2	3	4	5	6	7	8	9	10	11	12	32
15-30	21	15	18	7	8	39	74	186	130	125	114	156	162	178	152	232	268	309	230	210	187	141	114	58	57
30-45	24	15	14	12	11	40	113	194	140	122	118	128	137	175	180	226	250	270	210	136	142	108	49	38	
45-00	18	23	11	6	24	74	137	214	139	128	130	152	185	170	200	212	249	222	220	140	129	92	56	31	
TOT	95	63	59	43	53	172	391	729	538	506	476	562	639	709	688	890	985	1093	861	652	563	447	238	161	11613

AM PEAK HOUR 0700 TO 0800 VOLUME 729
 PM PEAK HOUR 0445 TO 0545 VOLUME 1120

04/22/15 WEDNESDAY	AM HOURS												PM HOURS												DAILY TOTAL	
	1	2	3	4	5	6	7	8	9	10	11	12	1	2	3	4	5	6	7	8	9	10	11	12		
12	1	2	3	4	5	6	7	8	9	10	11	12	1	2	3	4	5	6	7	8	9	10	11	12	31	
15-30	21	18	16	6	5	44	77	167	142	104	137	165	169	176	172	202	196	192	247	267	215	156	135	136	84	55
30-45	22	14	15	3	11	48	92	188	149	110	105	140	154	149	181	172	172	224	239	323	218	162	112	116	71	55
45-00	15	11	16	14	20	74	140	182	166	132	130	156	174	182	175	175	229	241	228	207	153	134	78	50	38	
TOT	89	54	56	34	43	197	379	659	621	475	479	635	659	709	724	875	994	1101	856	609	518	439	260	180	11643	

AM PEAK HOUR 0715 TO 0815 VOLUME 701
 PM PEAK HOUR 0445 TO 0545 VOLUME 1114

DOT-RNB515A-B

STATE OF WASHINGTON - DEPARTMENT OF TRANSPORTATION
TRIP SYSTEM
15 MINUTE TRAFFIC COUNT SUMMARY

DATE 04/29/15
TIME 10:31:21
PAGE 92

SR 500 P100480 MP 000.04

OFF SYSTEM ID.

LEG 2

DIRECTION OF TRAFFIC EASTBOUND

LANE ALL OF

COUNT IDENTIFIER 15-001

COUNTER NUMBER 178693

DESCRIPTION: ON SR 500 EB OFF RAMP TO NE 112TH AVE

04/23/15 THURSDAY

AM HOURS

PM HOURS

AM TOTAL

PM TOTAL

DAILY TOTAL

00-15	31	19	12	11	8	22	60	125	145	131	155	156	178	182	209	227	304	195	181	141	115	68	51
15-30	26	13	12	9	10	89	89	197	128	135	136	140	178	171	258	239	322	221	172	127	108	68	60
30-45	19	15	14	6	15	44	90	191	144	120	136	155	181	217	231	256	245	189	141	143	85	52	27
45-00	20	17	13	9	21	82	131	179	149	131	137	168	170	178	210	246	270	209	183	154	109	78	65
TOT	96	64	58	35	54	192	370	692	566	525	524	632	621	715	780	924	992	1080	788	628	520	386	253

AM PEAK HOUR 0715 TO 0815 VOLUME 712
PM PEAK HOUR 0430 TO 0530 VOLUME 1152

AM TOTAL 3808
PM TOTAL 7854

04/24/15 FRIDAY

AM HOURS

PM HOURS

AM TOTAL

PM TOTAL

DAILY TOTAL

00-15	12	1	2	3	4	5	6	7	8	9	10	11	12	1	2	3	4	5	6	7	8	9	10	11
15-30	1	2	3	4	5	6	7	8	9	10	11	12	1	2	3	4	5	6	7	8	9	10	11	12
30-45	24	17	18	10	9	21	58	114	129	136	140	140	178	171	258	239	322	221	172	127	108	68	60	
45-00	28	11	18	7	15	33	82	161	146	144	120	136	155	181	217	231	256	245	189	141	143	85	52	
TOT	91	59	62	38	50	175	356	659	416	374	373	416	416	524	524	632	621	715	780	924	992	1080	788	

AM PEAK HOUR 0715 TO 0815 VOLUME 674
PM PEAK HOUR 0000 TO 0000 VOLUME 0

AM TOTAL 1906
PM TOTAL 0

04/20/15 THRU 04/24/15
TOTAL HOURS FOR COUNT 89

3 DAYS
AVG WEEKDAY VOL 11639 X SEASONAL ADJ. FACTOR 0.9400 = 10941 X AXLE CORR FACTOR 0.9810 = ESTIMATED AVG DAILY TRAFFIC 10733
PEAK HOUR PERCENTAGES: K = 9.90 D = 100.00
PEAK HOUR LOCATION : VOLUME = 1152 DATE: 04/23/15 TIME: 04:30 PM



RU

Interval 60 min. 15 min.
 Binned(CL/SP) Count(volume)
 Lane No 1 2

Direction Channel 1 _____
 Direction Channel 2 _____
 Unique ID# _____

Counter No. 174648 Count ID 15-001
 SR 500 RRT/RRQ S1 00526 MP 0.00
 Leg 2 Direction WB OSID _____

Station Description ON SR 500 WB ON RAMP FROM NE GHER RD

Date	Day	Time	Comments				
4-20-15	2	1411	Manual (1) <u>1</u> (2) _____ Counter (1) <u>1</u> (2) _____	Set Cntrs	OK	TWB/DB	6.6
4-21-15	3	1235	Manual (1) <u>50</u> (2) _____ Counter (1) <u>50</u> (2) _____	Check Cntrs	OK	TWB/DB	6.4
4-22-15	4	0927	Manual (1) <u>50</u> (2) _____ Counter (1) <u>50</u> (2) _____	Check Cntrs	OK	TWB/DB	7.0
4-23-15	5	1041	Manual (1) <u>50</u> (2) _____ Counter (1) <u>50</u> (2) _____	Check Cntrs	OK	TWB/DB	7.0
4-24-15	6	0832	Manual (1) <u>1</u> (2) _____ Counter (1) <u>1</u> (2) _____	P/U Cntrs	OK	TWB/DB	6.6

Sketch

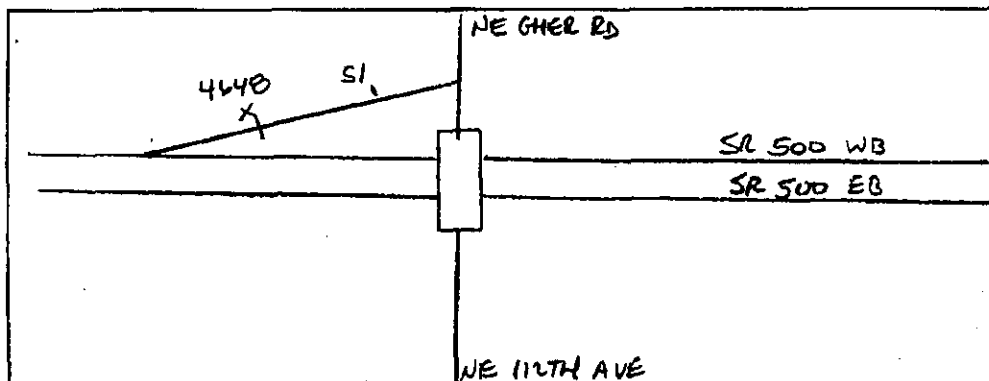

T. BREUDEL

Field Person

SR 500 S100526 MP 000.00 OFF SYSTEM ID. LEG 2 DIRECTION OF TRAFFIC WESTBOUND LANE ALL OF

COUNT IDENTIFIER 15-001 COUNTER NUMBER 174648 DESCRIPTION: ON SR 500 WB ON RAMP FROM NE GHER RD

COUNT IDENTIFIER	04/20/15 MONDAY												DAILY TOTAL
	AM HOURS												
15-30	15-30	30-45	45-00	00-15	15-30	30-45	45-00	00-15	15-30	30-45	45-00	TOT	
12	1	2	3	4	5	6	7	8	9	10	11	12	799
1	2	3	4	5	6	7	8	9	10	11	12	1	1105
245	267	309	301	292	291	292	292	292	292	292	292	292	1105
266	293	290	301	292	291	292	292	292	292	292	292	292	1105
288	254	314	291	292	291	292	292	292	292	292	292	292	1105
TOT	799	1105	1205	1249	934	624	581	402	289	149	7337	7337	

AM PEAK HOUR 0000 TO 0000 VOLUME 0
 PM PEAK HOUR 0445 TO 0545 VOLUME 1272
 AM TOTAL 7337
 PM TOTAL 7337

COUNT IDENTIFIER	04/21/15 TUESDAY												DAILY TOTAL	
	AM HOURS													
15-30	15-30	30-45	45-00	00-15	15-30	30-45	45-00	00-15	15-30	30-45	45-00	TOT		
12	1	2	3	4	5	6	7	8	9	10	11	12	92	
1	2	3	4	5	6	7	8	9	10	11	12	1	63	
26	20	15	19	33	106	296	271	351	270	236	199	242	226	
24	17	17	27	68	132	286	330	291	263	230	229	238	225	
20	13	19	36	101	224	321	327	317	263	240	252	231	229	
22	13	24	30	75	238	280	365	299	273	206	253	207	235	
TOT	92	63	75	112	277	700	1183	1293	1258	1069	914	944	939	
														1148
														1198
														1211
														1018
														699
														560
														445
														251
														163
														17593

AM PEAK HOUR 0715 TO 0815 VOLUME 1373
 PM PEAK HOUR 0445 TO 0545 VOLUME 1285
 AM TOTAL 7980
 PM TOTAL 9613

COUNT IDENTIFIER	04/22/15 WEDNESDAY												DAILY TOTAL	
	AM HOURS													
15-30	15-30	30-45	45-00	00-15	15-30	30-45	45-00	00-15	15-30	30-45	45-00	TOT		
12	1	2	3	4	5	6	7	8	9	10	11	12	78	
1	2	3	4	5	6	7	8	9	10	11	12	1	46	
25	15	21	13	35	117	304	297	320	271	229	208	224	264	
15	11	20	29	62	160	296	336	290	291	211	233	250	291	
21	11	16	36	100	223	329	355	328	285	264	273	249	279	
17	9	16	32	76	210	280	379	278	253	261	232	280	244	
TOT	78	46	73	110	273	710	1209	1367	1216	1101	965	946	1003	
														1039
														1120
														1133
														1195
														1175
														997
														702
														599
														518
														291
														161
														18027

AM PEAK HOUR 0715 TO 0815 VOLUME 1390
 PM PEAK HOUR 0445 TO 0545 VOLUME 1235
 AM TOTAL 8094
 PM TOTAL 9935

SR 500 S100526 MP 000.00 OFF SYSTEM ID. LEG 2 DIRECTION OF TRAFFIC WESTBOUND LANE ALL OF

COUNT IDENTIFIER 15-001 COUNTER NUMBER 174648 DESCRIPTION: ON SR 500 WB ON RAMP FROM NE GRER RD

04/23/15 THURSDAY	AM HOURS												PM HOURS												DAILY TOTAL
	1	2	3	4	5	6	7	8	9	10	11	12	1	2	3	4	5	6	7	8	9	10	11	12	
12	1	2	3	4	5	6	7	8	9	10	11	12	1	2	3	4	5	6	7	8	9	10	11	12	17774
63	74	84	103	259	704	1201	1377	1196	1109	979	1039	1029	956	997	1139	1208	1230	991	670	514	412	274	166	8188	
AM PEAK HOUR 0700 TO 0800 VOLUME 1377												PM PEAK HOUR 0430 TO 0530 VOLUME 1282												AM TOTAL 8188	
PM PEAK HOUR 0430 TO 0530 VOLUME 1282																								PM TOTAL 9586	

04/24/15 FRIDAY	AM HOURS												PM HOURS												DAILY TOTAL
	1	2	3	4	5	6	7	8	9	10	11	12	1	2	3	4	5	6	7	8	9	10	11	12	
12	1	2	3	4	5	6	7	8	9	10	11	12	1	2	3	4	5	6	7	8	9	10	11	12	4197
84	70	72	114	234	638	1106	1253	626																	4197
AM PEAK HOUR 0730 TO 0830 VOLUME 1294												PM PEAK HOUR 0000 TO 0000 VOLUME 0												AM TOTAL 4197	
PM PEAK HOUR 0000 TO 0000 VOLUME 0																								PM TOTAL 0	

04/20/15 THRU 04/24/15 TOTAL HOURS FOR COUNT 89
 3 DAYS
 AVG WEEKDAY VOL 17798 X SEASONAL ADJ. FACTOR 0.9400 = 16730 X AXLE CORR FACTOR 0.9810 = ESTIMATED AVG DAILY TRAFFIC 16412
 PEAK HOUR PERCENTAGES: K = 7.81 D = 100.00
 PEAK HOUR LOCATION : VOLUME = 1390 DATE: 04/22/15 TIME: 07:15 AM



Washington State
Department of Transportation

Diamond Traffic Counter

Ru

Interval 60 min. 15 min.
 Binned(CL/SP) Count(volume)
Lane No 1 2

Direction Channel 1 MAINLINE U
Direction Channel 2 R1 00579 WB
Unique ID# _____

Counter No. 172315 Count ID 15-001
SR 500 RRT/RRQ R1 00579 MP 0.00
Leg 2 Direction See 1,2 OSID _____

Station Description ON SR 500 WB OFF RAMP TO NE GHER RD

Date	Day	Time	Comments
4-20-15	2	1356	Manual (1) 1 (2) 1 Counter (1) 1 (2) 1 Set Cntrs OK TWB/DB 6.5
4-21-15	3	1227	Manual (1) 50 (2) 8 Counter (1) 50 (2) 8 Check Cntrs OK TWB/DB 6.8
4-22-15	4	0923	Manual (1) 50 (2) 7 Counter (1) 50 (2) 7 Check Cntrs OK TWB/DB 6.9
4-23-15	5	1035	Manual (1) 50 (2) 7 Counter (1) 50 (2) 7 Check Cntrs OK TWB/DB 7.2
4-24-15	6	0827	Manual (1) 1 (2) _____ Counter (1) 1 (2) _____ P/U Cntrs OK TWB/DB 6.5

Sketch

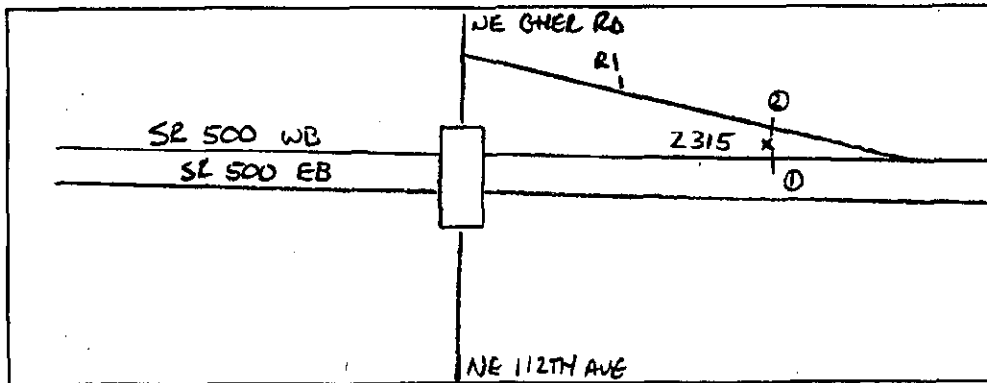

T. Breckner
Field Person

DOT-RNB515A-B

STATE OF WASHINGTON - DEPARTMENT OF TRANSPORTATION

TRIP SYSTEM
15 MINUTE TRAFFIC COUNT SUMMARY

DATE 04/29/15
TIME 10:31:21
PAGE 95

SR 500 R100579 MP 000.00 OFF SYSTEM ID. LEG 2 DIRECTION OF TRAFFIC WESTBOUND LANE ALL OF
COUNT-IDENTIFIER 15-001 COUNTER NUMBER 172315 DESCRIPTION: ON SR 500 WB OFF RAMP TO NE GNER RD

04/20/15 MONDAY	AM HOURS												PM HOURS												DAILY TOTAL
	1	2	3	4	5	6	7	8	9	10	11	12	1	2	3	4	5	6	7	8	9	10	11	12	
00-15	1	2	3	4	5	6	7	8	9	10	11	12	1	2	3	4	5	6	7	8	9	10	11	12	1480
15-30	1	2	3	4	5	6	7	8	9	10	11	12	1	2	3	4	5	6	7	8	9	10	11	12	1480
30-45	1	2	3	4	5	6	7	8	9	10	11	12	1	2	3	4	5	6	7	8	9	10	11	12	1480
45-00	1	2	3	4	5	6	7	8	9	10	11	12	1	2	3	4	5	6	7	8	9	10	11	12	1480
TOT	12	12	12	12	12	12	12	12	12	12	12	12	12	12	12	12	12	12	12	12	12	12	12	12	1480

AM PEAK HOUR 0000 TO 0000 VOLUME 0
PM PEAK HOUR 0445 TO 0545 VOLUME 218

AM TOTAL 1480
PM TOTAL 1480

04/21/15 TUESDAY	AM HOURS												PM HOURS												DAILY TOTAL
	1	2	3	4	5	6	7	8	9	10	11	12	1	2	3	4	5	6	7	8	9	10	11	12	
00-15	1	2	3	4	5	6	7	8	9	10	11	12	1	2	3	4	5	6	7	8	9	10	11	12	3024
15-30	1	2	3	4	5	6	7	8	9	10	11	12	1	2	3	4	5	6	7	8	9	10	11	12	3024
30-45	1	2	3	4	5	6	7	8	9	10	11	12	1	2	3	4	5	6	7	8	9	10	11	12	3024
45-00	1	2	3	4	5	6	7	8	9	10	11	12	1	2	3	4	5	6	7	8	9	10	11	12	3024
TOT	10	8	7	7	10	18	78	99	201	178	185	186	182	166	200	188	225	210	227	147	124	109	46	20	3024

AM PEAK HOUR 0715 TO 0815 VOLUME 215
PM PEAK HOUR 0430 TO 0530 VOLUME 229

AM TOTAL 1180
PM TOTAL 1844

04/22/15 WEDNESDAY	AM HOURS												PM HOURS												DAILY TOTAL
	1	2	3	4	5	6	7	8	9	10	11	12	1	2	3	4	5	6	7	8	9	10	11	12	
00-15	1	2	3	4	5	6	7	8	9	10	11	12	1	2	3	4	5	6	7	8	9	10	11	12	3065
15-30	1	2	3	4	5	6	7	8	9	10	11	12	1	2	3	4	5	6	7	8	9	10	11	12	3065
30-45	1	2	3	4	5	6	7	8	9	10	11	12	1	2	3	4	5	6	7	8	9	10	11	12	3065
45-00	1	2	3	4	5	6	7	8	9	10	11	12	1	2	3	4	5	6	7	8	9	10	11	12	3065
TOT	14	7	11	11	13	87	109	189	161	195	182	178	222	205	191	215	204	204	195	168	139	88	43	34	3065

AM PEAK HOUR 0845 TO 0945 VOLUME 201
PM PEAK HOUR 0330 TO 0430 VOLUME 233

AM TOTAL 1157
PM TOTAL 1908

DOT-RN8515A-B

STATE OF WASHINGTON - DEPARTMENT OF TRANSPORTATION
TRIP SYSTEM
15 MINUTE TRAFFIC COUNT SUMMARY

DATE 04/29/15
TIME 10:31:21
PAGE 96

SR 500 R100579 MP 000.00 OFF SYSTEM ID. LEG 2 DIRECTION OF TRAFFIC WESTBOUND LANE ALL OF

COUNT IDENTIFIER 15-001 COUNTER NUMBER 172315 DESCRIPTION: ON SR 500 WB OFF RAMP TO NE GHER RD

04/23/15 THURSDAY		AM HOURS												PM HOURS					DAILY TOTAL							
		1	2	3	4	5	6	7	8	9	10	11	12	1	2	3	4	5	6	7	8	9	10	11	12	
00-15	12	1	2	3	4	5	6	7	8	9	10	11	12	1	2	3	4	5	6	7	8	9	10	11	12	487
15-30	9	3	4	2	2	1	9	20	41	33	42	40	35	40	40	38	51	61	48	42	32	30	17	6	2766	
30-45	3	2	1	5	3	2	21	48	42	42	38	40	45	48	42	47	41	49	51	25	28	25	15	7		
45-00	1	1	4	3	4	4	16	31	51	58	32	40	45	48	42	55	55	69	48	36	41	19	20	5		
TOT	17	9	7	14	16	78	114	208	197	150	161	158	184	175	183	174	211	231	192	134	120	98	59	22	2912	
									AM PEAK HOUR 0700 TO 0800 VOLUME 208												AM TOTAL 1129					
									PM PEAK HOUR 0500 TO 0600 VOLUME 231												PM TOTAL 1783					

04/24/15 FRIDAY		AM HOURS												PM HOURS					DAILY TOTAL							
		1	2	3	4	5	6	7	8	9	10	11	12	1	2	3	4	5	6	7	8	9	10	11	12	
00-15	12	1	2	3	4	5	6	7	8	9	10	11	12	1	2	3	4	5	6	7	8	9	10	11	12	487
15-30	3	3	3	5	3	9	17	27	50																	2766
30-45	3	4	2	2	1	25	22	50																		
45-00	9	1	4	3	4	14	21	63																		
TOT	18	10	12	13	12	73	99	200	50																	487
									AM PEAK HOUR 0715 TO 0815 VOLUME 223												AM TOTAL 487					
									PM PEAK HOUR 0000 TO 0000 VOLUME 0												PM TOTAL 0					

04/20/15 THRU 04/24/15 TOTAL HOURS FOR COUNT 90

3 DAYS
 AVG WEEKDAY VOL 3000 X SEASONAL ADJ. FACTOR 0.9400 = 2820 X AXLE CORR FACTOR 0.9810 = ESTIMATED AVG DAILY TRAFFIC 2766
 PEAK HOUR PERCENTAGES: K = 7.77 D = 100.00
 PEAK HOUR LOCATION : VOLUME = 233 DATE: 04/22/15 TIME: 03:30 PM



Ru

Interval 60 min. 15 min.
 Binned(CL/SP) Count(volume)
Lane No 1 2

Direction Channel 1 MAINLINE U
Direction Channel 2 Q1 00583 EB
Unique ID# _____

Counter No. 175863 Count ID 15-001
SR 500 RRT/RRQ Q1 00583 MP 1.00
Leg 2 Direction See 1,2 OSID _____

Station Description ON SR 500 EB ON RAMP FROM NE 112TH AVE

Date	Day	Time	Comments				
4-20-15	2	1311	Manual (1) 1 (2) 1 Counter (1) 1 (2) 1	Set Cntrs	OK	TWB/DB	6.4
4-21-15	3	1215	Manual (1) 50 (2) 15 Counter (1) 50 (2) 15	Check Cntrs	OK	TWB/DB	6.9
4-22-15	4	0917	Manual (1) 50 (2) 5 Counter (1) 50 (2) 5	Check Cntrs	OK	TWB/DB	6.9
4-23-15	5	1028	Manual (1) 50 (2) 5 Counter (1) 50 (2) 5	Check Cntrs	OK	TWB/DB	7.0
4-24-15	6	0820	Manual (1) 1 (2) _____ Counter (1) 1 (2) _____	P/U Cntrs	OK	TWB/DB	6.5

Sketch

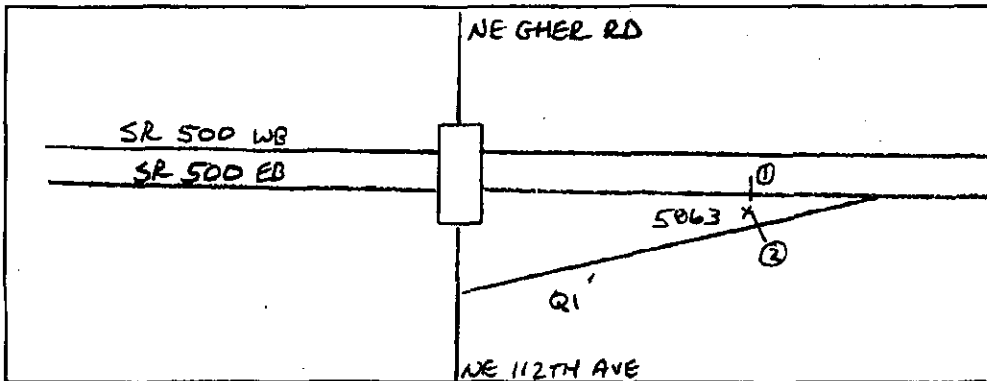

North

T. BREUDEL
Field Person

DOT-RNB515A-8

STATE OF WASHINGTON - DEPARTMENT OF TRANSPORTATION
TRIP SYSTEM
15 MINUTE TRAFFIC COUNT SUMMARY

DATE 06/29/15
TIME 10:31:21
PAGE 97

SR 500 0100583 MP 000.00 OFF SYSTEM ID. LEG 2 DIRECTION OF TRAFFIC EASTBOUND LANE ALL OF
COUNT IDENTIFIER 15-001 COUNTER NUMBER 175863 DESCRIPTION: ON SR 500 EB ON RAMP FROM NE 112TH AVE

04/20/15 MONDAY	AM HOURS	1	2	3	4	5	6	7	8	9	10	11	12	PM HOURS	1	2	3	4	5	6	7	8	9	10	11	12	DAILY TOTAL
00-15																											
15-30	12	1	2	3	4	5	6	7	8	9	10	11	12														
30-45	1	2	3	4	5	6	7	8	9	10	11	12	1	2	3	4	5	6	7	8	9	10	11	12			
45-00																											
TOT																											

AM PEAK HOUR 0000 TO 0000 VOLUME 0
PM PEAK HOUR 0345 TO 0445 VOLUME 261

AM TOTAL 1817
PM TOTAL 0

04/21/15 TUESDAY	AM HOURS	1	2	3	4	5	6	7	8	9	10	11	12	PM HOURS	1	2	3	4	5	6	7	8	9	10	11	12	DAILY TOTAL
00-15																											
15-30	12	1	2	3	4	5	6	7	8	9	10	11	12														
30-45	1	2	3	4	5	6	7	8	9	10	11	12	1	2	3	4	5	6	7	8	9	10	11	12			
45-00																											
TOT																											

AM PEAK HOUR 0945 TO 1045 VOLUME 198
PM PEAK HOUR 0400 TO 0500 VOLUME 267

AM TOTAL 1108
PM TOTAL 2162

04/22/15 WEDNESDAY	AM HOURS	1	2	3	4	5	6	7	8	9	10	11	12	PM HOURS	1	2	3	4	5	6	7	8	9	10	11	12	DAILY TOTAL
00-15																											
15-30	12	1	2	3	4	5	6	7	8	9	10	11	12														
30-45	1	2	3	4	5	6	7	8	9	10	11	12	1	2	3	4	5	6	7	8	9	10	11	12			
45-00																											
TOT																											

AM PEAK HOUR 1030 TO 1130 VOLUME 213
PM PEAK HOUR 0300 TO 0400 VOLUME 288

AM TOTAL 1116
PM TOTAL 2188

04/22/15 WEDNESDAY	AM HOURS	1	2	3	4	5	6	7	8	9	10	11	12	PM HOURS	1	2	3	4	5	6	7	8	9	10	11	12	DAILY TOTAL
00-15																											
15-30	12	1	2	3	4	5	6	7	8	9	10	11	12														
30-45	1	2	3	4	5	6	7	8	9	10	11	12	1	2	3	4	5	6	7	8	9	10	11	12			
45-00																											
TOT																											

AM PEAK HOUR 1030 TO 1130 VOLUME 213
PM PEAK HOUR 0300 TO 0400 VOLUME 288

AM TOTAL 1116
PM TOTAL 2188

DOT-RNB515A-B

STATE OF WASHINGTON - DEPARTMENT OF TRANSPORTATION
TRIP SYSTEM
15 MINUTE TRAFFIC COUNT SUMMARY

DATE 04/29/15
TIME 10:31:21
PAGE 98

SR 500 Q100583 MP 000.00 OFF SYSTEM ID. LEG 2 DIRECTION OF TRAFFIC EASTBOUND LANE ALL OF

COUNT IDENTIFIER 15-001 COUNTER NUMBER 175863 DESCRIPTION: ON SR 500 EB ON RAMP FROM NE 112TH AVE

04/23/15 THURSDAY	AM HOURS												PM HOURS												DAILY TOTAL
	1	2	3	4	5	6	7	8	9	10	11	12	1	2	3	4	5	6	7	8	9	10	11	12	
12	1	2	3	4	5	6	7	8	9	10	11	12	1	2	3	4	5	6	7	8	9	10	11	12	94
1	2	3	4	5	6	7	8	9	10	11	12	1	2	3	4	5	6	7	8	9	10	11	12	1084	
00-15	7	2	1	3	1	7	18	30	41	46	43	36	59	53	52	60	62	63	46	43	23	34	24	9	
15-30	3	6	7	4	5	17	40	40	33	36	37	61	50	57	60	73	68	57	46	57	44	18	13	4	
30-45	7	8	3	3	10	20	32	46	46	57	55	47	62	61	75	75	57	53	36	36	28	26	12	12	
45-00	3	4	5	5	6	17	41	49	50	39	47	47	52	58	63	60	74	53	71	41	26	16	10	6	
TOT	20	20	16	15	14	39	96	179	163	164	183	175	219	223	233	255	284	241	216	177	121	94	59	31	
									AM PEAK HOUR 0715 TO 0815 VOLUME												AM TOTAL				
									190												1084				
									PM PEAK HOUR 0415 TO 0515 VOLUME												PM TOTAL				
									285												2153				

04/24/15 FRIDAY	AM HOURS												PM HOURS												DAILY TOTAL
	1	2	3	4	5	6	7	8	9	10	11	12	1	2	3	4	5	6	7	8	9	10	11	12	
12	1	2	3	4	5	6	7	8	9	10	11	12	1	2	3	4	5	6	7	8	9	10	11	12	428
1	2	3	4	5	6	7	8	9	10	11	12	1	2	3	4	5	6	7	8	9	10	11	12	186	
00-15	9	4	4	2	2	3	19	31	40																
15-30	5	2	2	3	1	10	20	20	46																
30-45	8	6	6	3	4	15	20	50																	
45-00	6	3	2	2	5	17	36	48																	
TOT	28	15	8	10	12	45	95	175	40																
									AM PEAK HOUR 0715 TO 0815 VOLUME												AM TOTAL				
									186												428				
									PM PEAK HOUR 0000 TO 0000 VOLUME												PM TOTAL				
									0												0				

04/20/15 THRU 04/24/15 TOTAL HOURS FOR COUNT 90

3 DAYS AVG WEEKDAY VOL 3270 X SEASONAL ADJ. FACTOR 0.9400 = 3074 X AXLE CORR FACTOR 0.9810 = ESTIMATED AVG DAILY TRAFFIC 3016

PEAK HOUR PERCENTAGES: K = 8.81 D = 100.00

PEAK HOUR LOCATION : VOLUME = 288 DATE: 04/22/15 TIME: 03:00 PM