

**LOCATION:** SE 192nd Ave -- SE 15th St  
**CITY/STATE:** Camas, WA

**QC JOB #:** 14421313  
**DATE:** Thu, Jun 08 2017

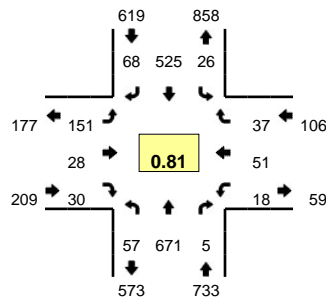

**Peak-Hour: 7:30 AM -- 8:30 AM**  
**Peak 15-Min: 7:45 AM -- 8:00 AM**

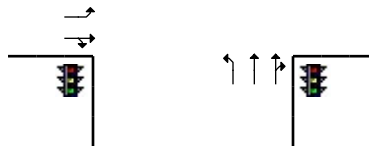
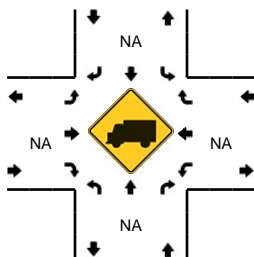
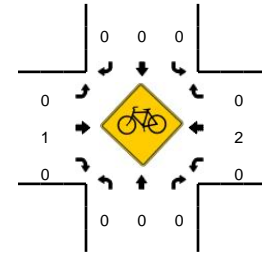
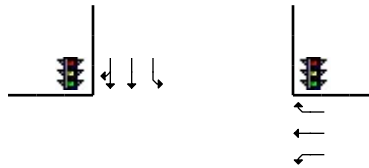
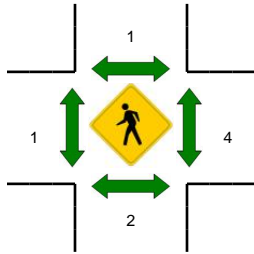
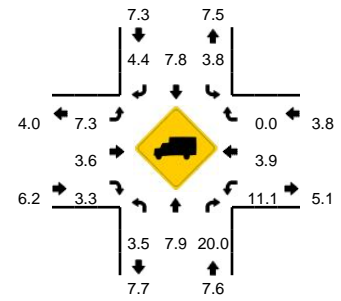

5-Min Count Period Beginning At	SE 192nd Ave (Northbound)				SE 192nd Ave (Southbound)				SE 15th St (Eastbound)				SE 15th St (Westbound)				Total	Hourly Totals
	Left	Thru	Right	U	Left	Thru	Right	U	Left	Thru	Right	U	Left	Thru	Right	U		
7:00 AM	5	37	2	0	5	40	1	0	3	1	1	0	0	2	0	0	97	
7:05 AM	0	40	0	0	4	30	0	0	3	3	5	0	2	1	0	0	88	
7:10 AM	1	38	0	0	1	16	1	0	2	3	6	0	1	3	5	0	77	
7:15 AM	3	37	0	0	2	34	6	0	3	3	3	0	5	2	5	0	103	
7:20 AM	5	40	1	0	0	43	4	0	3	0	0	0	1	3	0	0	100	
7:25 AM	5	43	0	0	2	27	2	0	2	2	2	0	2	2	0	0	89	
7:30 AM	4	58	0	0	0	28	0	0	11	0	5	0	1	2	2	0	111	
7:35 AM	2	67	1	0	2	39	7	0	16	1	0	0	1	2	3	0	141	
7:40 AM	4	62	0	0	2	43	6	0	13	3	5	0	1	6	6	0	151	
7:45 AM	6	61	1	0	0	51	6	0	12	4	4	0	2	7	5	0	159	
7:50 AM	4	72	0	0	3	67	7	0	17	1	0	0	2	6	3	0	182	
7:55 AM	5	67	2	0	5	62	9	0	8	1	3	0	5	7	1	0	175	1473
8:00 AM	11	63	0	0	2	49	10	0	14	2	3	0	1	3	1	0	159	1535
8:05 AM	4	38	1	0	5	46	8	0	9	4	1	0	0	7	5	0	128	1575
8:10 AM	3	40	0	0	1	39	3	0	11	4	1	0	2	3	6	0	113	1611
8:15 AM	4	49	0	0	0	25	4	0	13	4	3	0	1	2	2	0	107	1615
8:20 AM	7	39	0	0	4	43	4	0	12	1	2	1	2	2	2	0	119	1634
8:25 AM	3	55	0	0	2	33	4	0	14	3	3	0	0	4	1	0	122	1667
8:30 AM	6	36	0	0	0	39	5	0	9	2	2	0	0	2	1	0	102	1658
8:35 AM	2	44	0	0	0	45	8	0	7	4	1	0	3	0	3	0	117	1634
8:40 AM	7	55	0	0	1	43	10	0	6	1	2	0	1	2	4	0	132	1615
8:45 AM	3	51	0	0	1	45	11	0	5	0	1	0	1	6	2	0	126	1582
8:50 AM	6	60	0	0	0	56	2	0	5	1	6	0	4	5	4	0	149	1549
8:55 AM	7	68	1	0	0	41	3	0	9	0	4	0	1	7	3	0	144	1518
Peak 15-Min Flowrates	Northbound				Southbound				Eastbound				Westbound				Total	
	Left	Thru	Right	U	Left	Thru	Right	U	Left	Thru	Right	U	Left	Thru	Right	U		
All Vehicles	60	800	12	0	32	720	88	0	148	24	28	0	36	80	36	0	2064	
Heavy Trucks	0	44	0	0	0	48	4	0	4	0	0	0	0	0	0	0	100	
Pedestrians		8				4				0				8			20	
Bicycles	0	0	0		0	0	0		0	1	0		0	2	0		3	
Railroad																		
Stopped Buses																		

Comments: